

GaAs MMIC VOLTAGE - VARIABLE ATTENUATOR, 20 - 50 GHz

Typical Applications

The HMC985 is ideal for:

- Point-to-Point Radio
- VSAT Radio
- Test Instrumentation
- Microwave Sensors
- Military, ECM & Radar

Functional Diagram

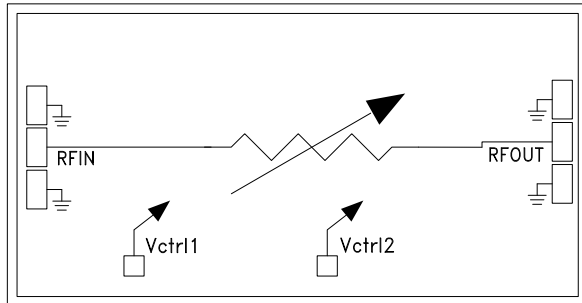

Features

- Wide Bandwidth: 20 - 50 GHz
- Excellent Linearity: +32 dB Input IP3
- Wide Attenuation Range: 35 dB
- Die Size: 2.78 x 1.37 x 0.1 mm

General Description

The HMC985 is an absorptive Voltage Variable Attenuator (VVA) which operates from 20 - 50 GHz and is ideal in designs where an analog DC control signal must be used to control RF signal levels over a 35 dB dynamic range. It features two shunt-type attenuators which are controlled by two analog voltages, Vctrl1 and Vctrl2. Optimum linearity performance of the attenuator is achieved by first varying Vctrl1 of the first attenuation stage from -3V to 0V with Vctrl2 fixed at -3V. The control voltage of the second attenuation stage, Vctrl2, should then be varied from -3V to 0V with Vctrl1 fixed at 0V.

However, if the Vctrl1 and Vctrl2 pins are connected together it is possible to achieve the full analog attenuation range with only a small degradation in input IP3 performance. Applications include AGC circuits and temperature compensation of multiple gain stages in microwave point to point and VSAT radios.

Electrical Specifications, $T_A = +25\text{ }^\circ\text{C}$, See Test Conditions

| Parameter | Condition | Min. | Typ. | Max. | Units |
|---|-----------|------|------|------|-------|
| Insertion Loss | 20 - 27 | | 3 | 3.5 | dB |
| | 27 - 35 | | 3 | 4 | dB |
| | 35 - 50 | | 3.5 | 4.5 | dB |
| Attenuation Range | 20 - 27 | 25 | 30 | | dB |
| | 27 - 35 | 30 | 35 | | dB |
| | 35 - 50 | 35 | 40 | | dB |
| Input Return Loss | | | 13 | | dB |
| Output Return Loss | | | 13 | | dB |
| Input Third Order Intercept (two-tone input Power = 10 dBm Each Tone) ^[1] | | | 33 | | dBm |

[1] VCTR2 = -3, VCTR1 = -2.0 worst case

**GaAs MMIC VOLTAGE - VARIABLE
ATTENUATOR, 20 - 50 GHz**

Attenuation vs. Frequency over V_{ctrl1} = Variable, $V_{ctrl2} = -3V$

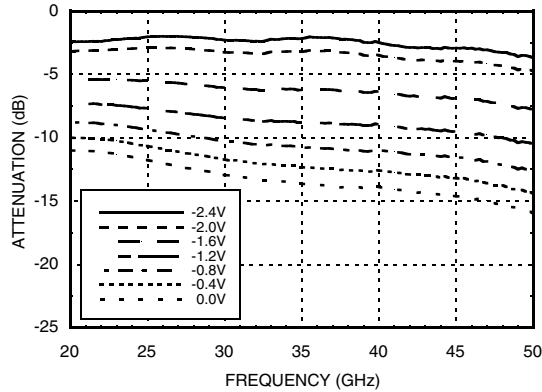

Attenuation vs. Frequency over $V_{ctrl1} = 0V$, V_{ctrl2} = Variable

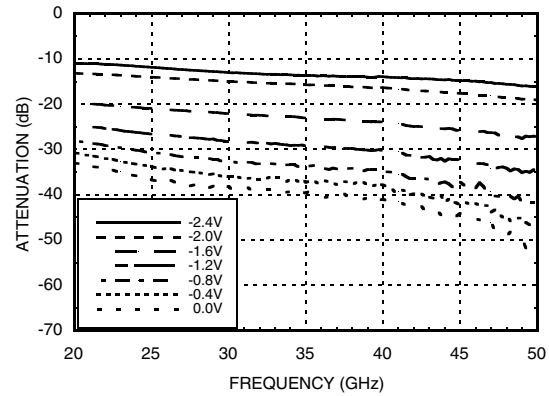

Attenuation vs. V_{ctrl1} Over Temperature @ 30 GHz, $V_{ctrl2} = -3V$

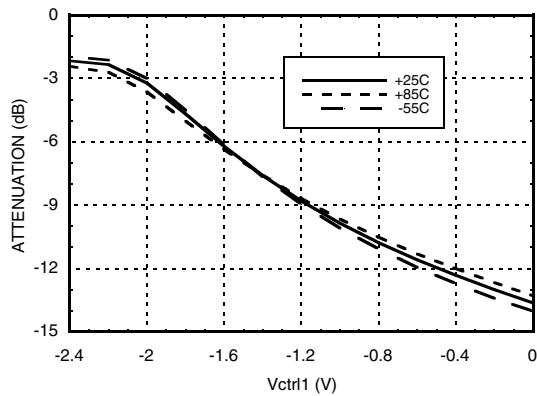

Attenuation vs. V_{ctrl2} Over Temperature @ 30 GHz, $V_{ctrl1} = 0V$

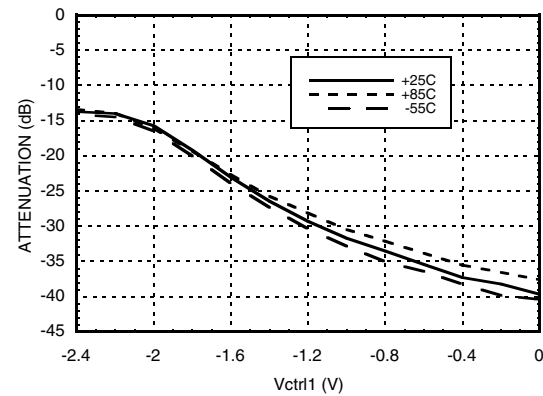

**Attenuation vs. P_{in} @ 30 GHz
 V_{ctrl1} = Variable, $V_{ctrl2} = -3V$**

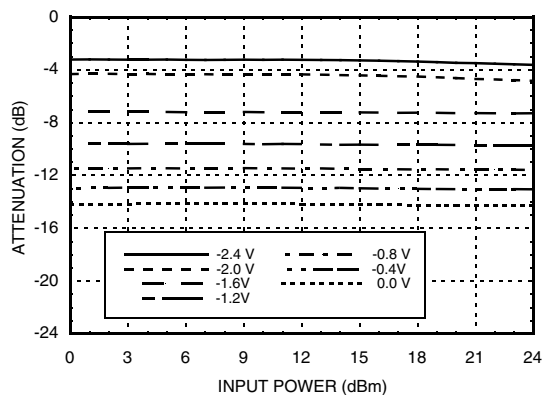

**Attenuation vs. P_{in} @ 30 GHz
 V_{ctrl2} = Variable, $V_{ctrl1} = 0V$**

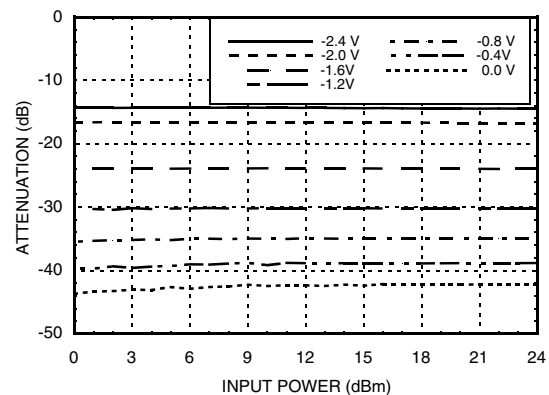

**GaAs MMIC VOLTAGE - VARIABLE
ATTENUATOR, 20 - 50 GHz**

0

ATTENUATORS - ANALOG - CHIP

Input Return Loss

Vctrl1 = Variable, Vctrl2 = -3V

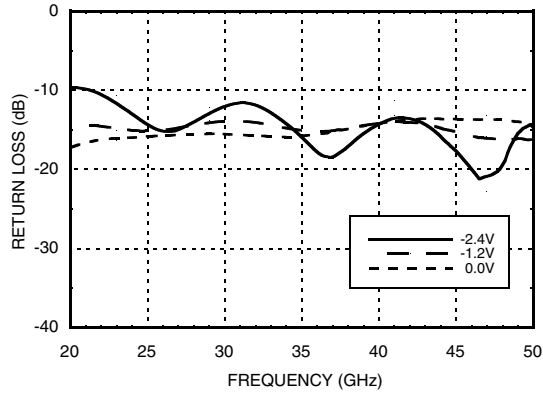

Input Return Loss

Vctrl1 = 0V, Vctrl2 = Variable

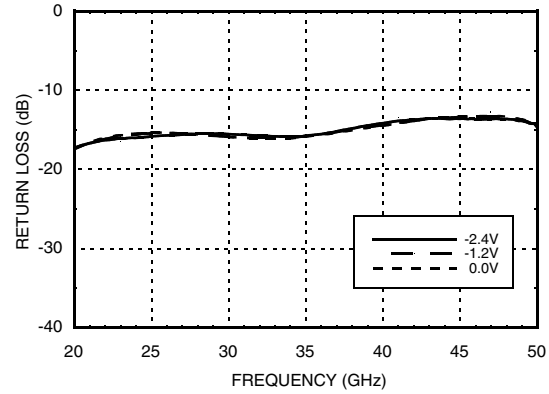

Output Return Loss

Vctrl1 = Variable, Vctrl2 = -3V

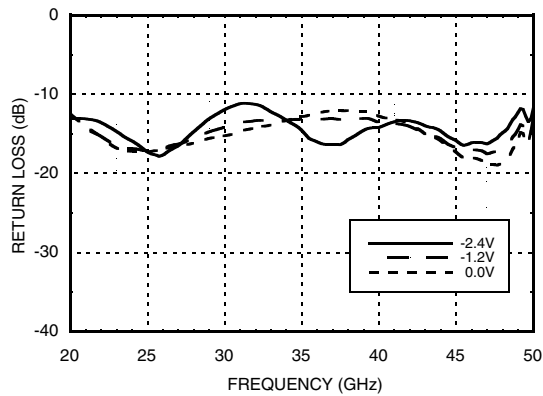

Output Return Loss

Vctrl1 = 0V, Vctrl2 = Variable

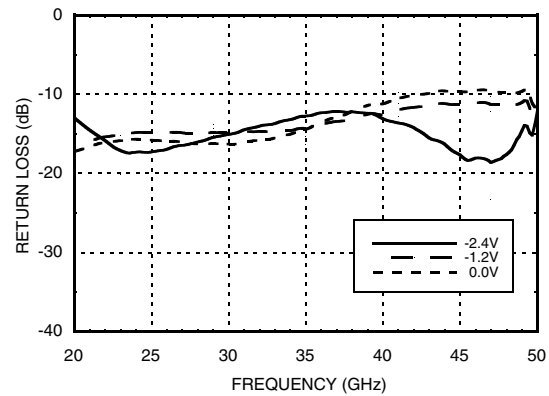

Input IP3 vs. Input Power @ 30 GHz

Vctrl1 = Variable, Vctrl2 = -3V

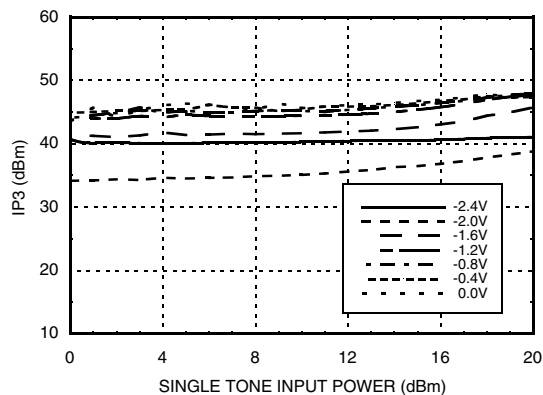

Input IP3 vs. Input Power @ 30 GHz

Vctrl1 = -2V, Vctrl2 = -3V [1]

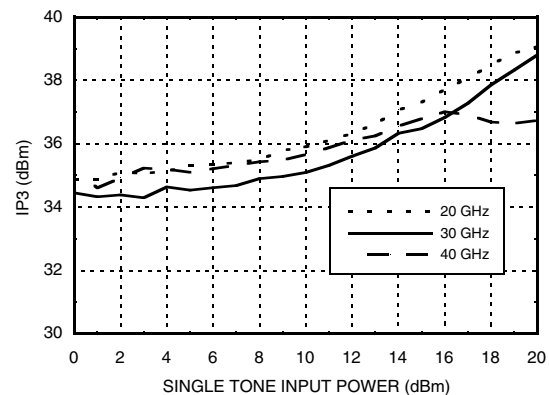

[1] Worst Case IP3

**GaAs MMIC VOLTAGE - VARIABLE
ATTENUATOR, 20 - 50 GHz**

**Input IP3 vs. Input Power Over Temperature
@ 30 GHz, Vctrl1 = -2V, Vctrl2 = -3V [1]**

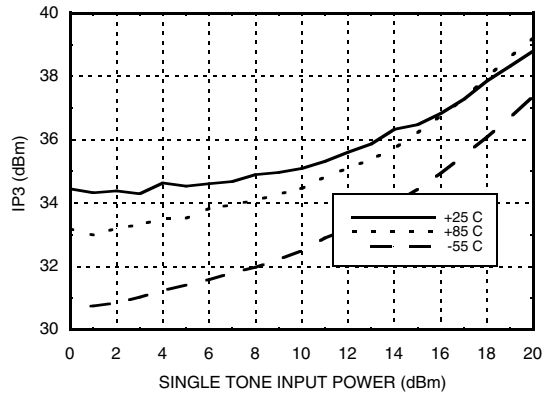

**Input IP3 vs. Input Power @ 30 GHz
Vctrl2 = Variable, Vctrl1 = 0V**

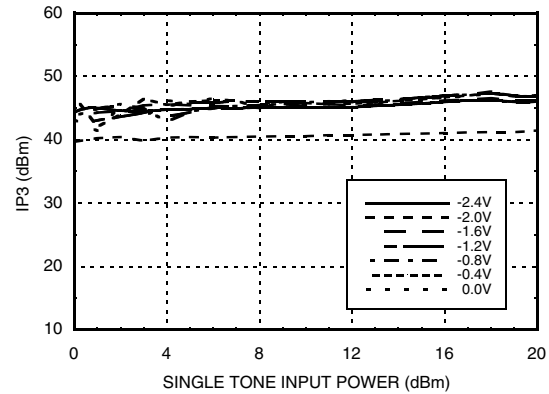

**Input IP3 vs. Input Power Over Frequency
Vctrl2 = -2V, Vctrl1 = 0V [1]**

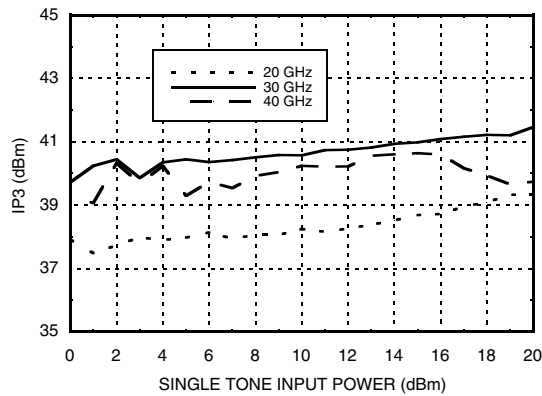

**Input IP3 vs Input Power over Temperature
@ 30 GHz, Vctrl2 = -2V, Vctrl1 = 0V [1]**

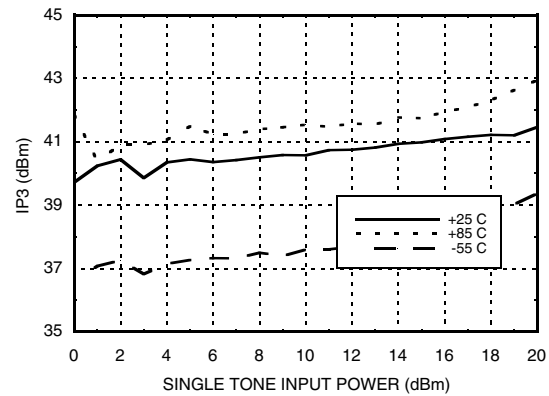

[1] Worst Case IP3

**GaAs MMIC VOLTAGE - VARIABLE
ATTENUATOR, 20 - 50 GHz**

0

ATTENUATORS - ANALOG - CHIP

Attenuation vs Frequency Over Vctrl
VCtrl1 = VCtrl2

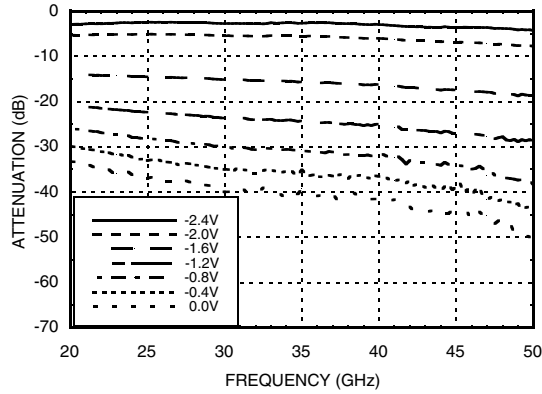

Attenuation vs. Vctrl Over Temperature
@ 35 GHz, VCtrl1 = VCtrl2

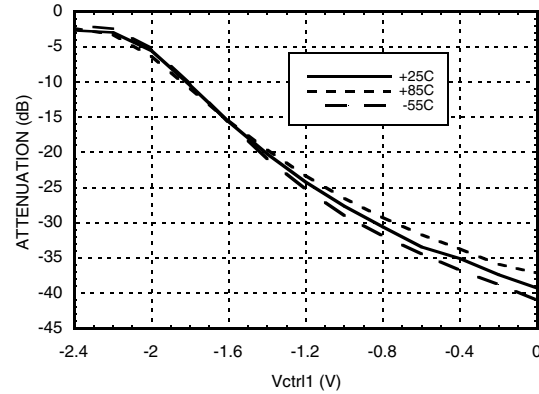

Attenuation vs. Pin @ 30 GHz Over Vctrl
VCtrl1 = VCtrl2

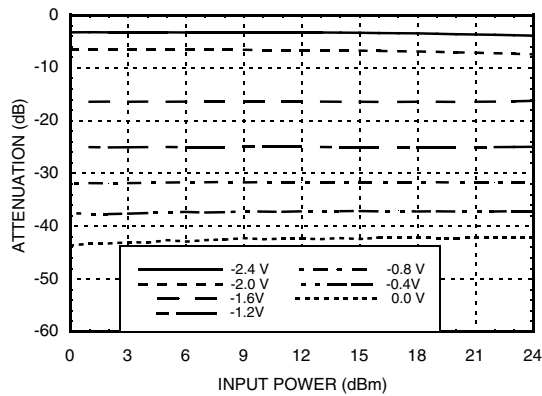

Input Return Loss, Vctrl1 = VCtrl2

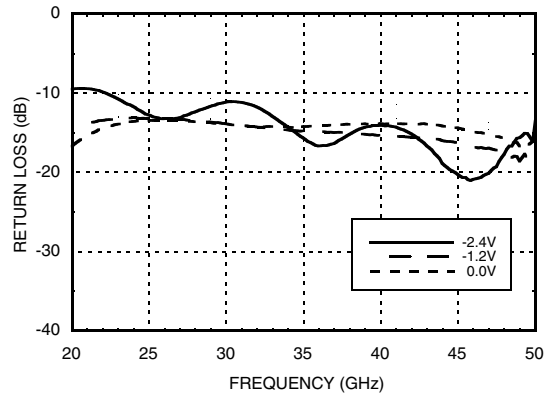

Output Return Loss, Vctrl1 = VCtrl2

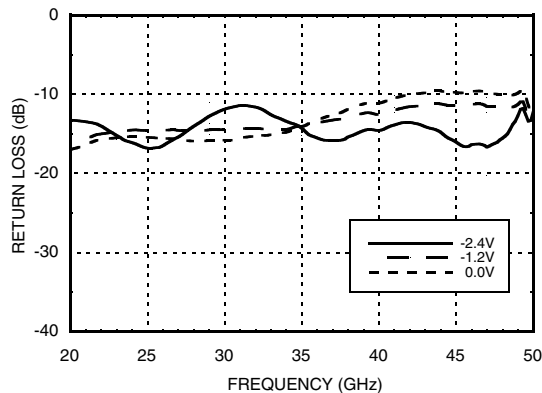

Input IP3 vs. Input Power Over Vctrl @ 30 GHz, VCtrl1 = VCtrl2

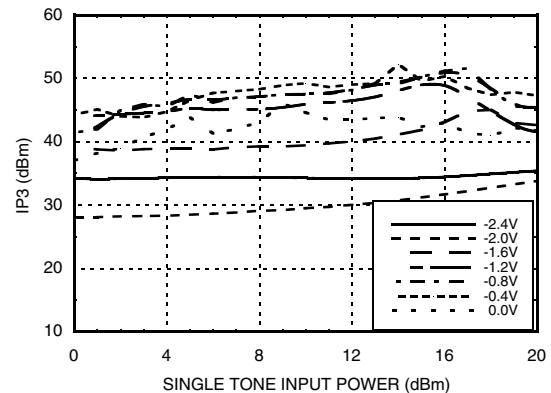

**GaAs MMIC VOLTAGE - VARIABLE
 ATTENUATOR, 20 - 50 GHz**

Input IP3 vs. Input Power Over Frequency
Vctrl1 = Vctrl2

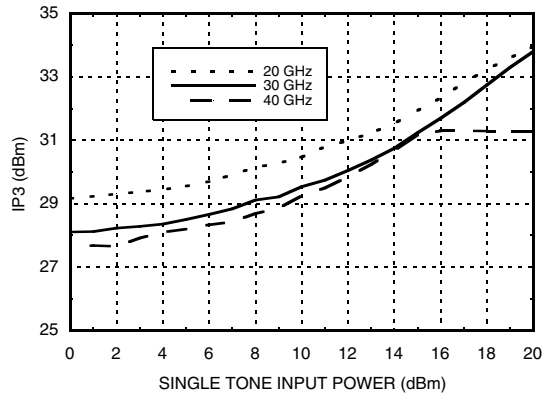

**Input IP3 vs. Input Power Over
 Temperature @ 30 GHz**
Vctrl1 = Vctrl2

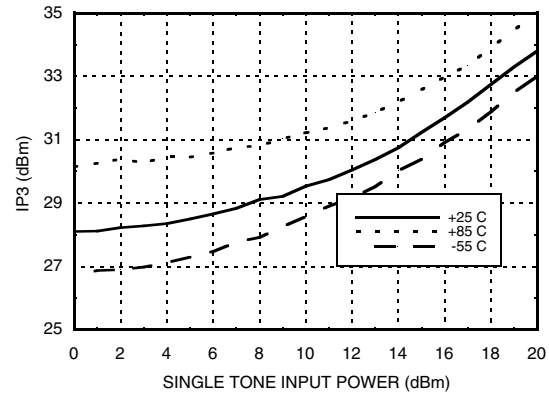

**GaAs MMIC VOLTAGE - VARIABLE
ATTENUATOR, 20 - 50 GHz**

0

ATTENUATORS - ANALOG - CHIP

Absolute Maximum Ratings

| | |
|--|----------------|
| Control Voltage | +1 to -5V |
| Input RF Power | 30 dBm |
| Maximum Junction Temperature | 165 °C |
| Thermal Resistance (R _{TH}) (junction to ground paddle) | 62 °C/W |
| Operating Temperature | -40°C to +85°C |
| Storage Temperature | -65°C to 125°C |



ELECTROSTATIC SENSITIVE DEVICE
OBSERVE HANDLING PRECAUTIONS

Outline Drawing

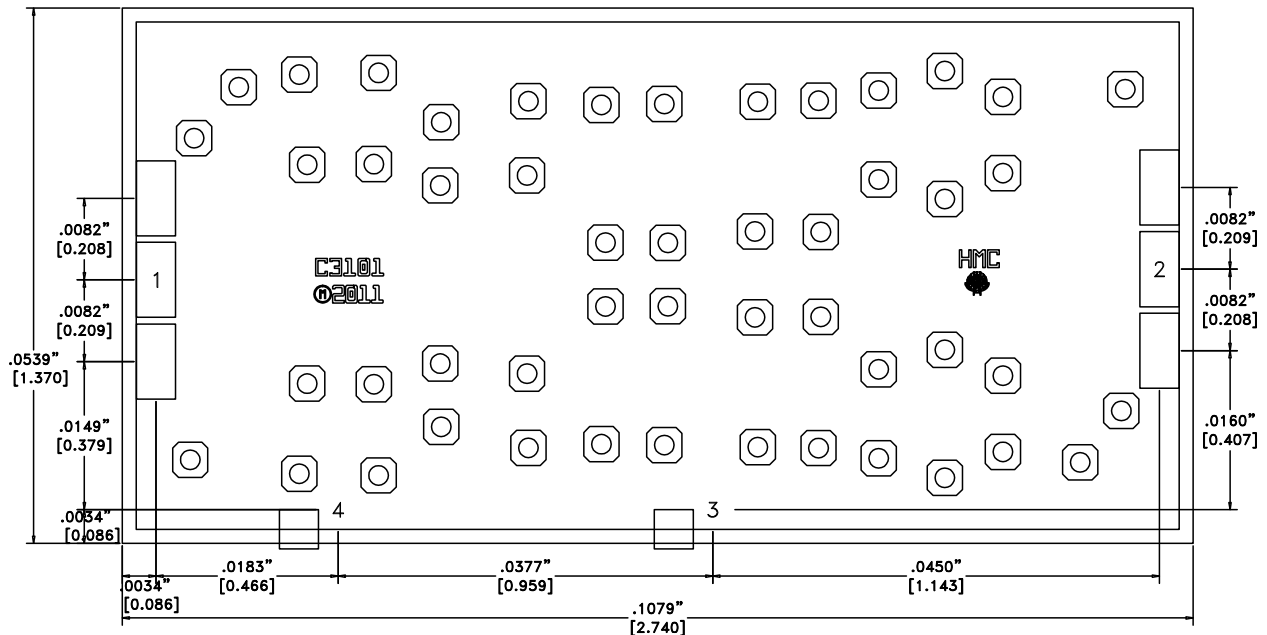

Die Packaging Information [1]

| Standard | Alternate |
|-----------------|-----------|
| GP-1 (Gel Pack) | [2] |



[1] Refer to the "Packaging Information" section for die packaging dimensions.

[2] For alternate packaging information contact Hittite Microwave Corporation.

NOTES:

1. ALL DIMENSIONS ARE IN INCHES [MM]
2. DIE THICKNESS IS .004"
3. TYPICAL BOND PAD IS 0.0026" [0.066] SQUARE
4. BACKSIDE METALLIZATION: GOLD
5. BOND PAD METALLIZATION: GOLD
6. BACKSIDE METAL IS GROUND.
7. CONNECTION NOT REQUIRED FOR UNLABELED BOND PADS.
8. OVERALL DIE SIZE ± .002

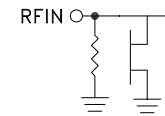
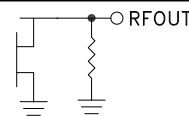
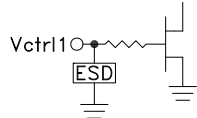
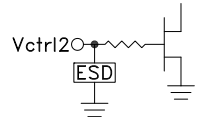
**GaAs MMIC VOLTAGE - VARIABLE
 ATTENUATOR, 20 - 50 GHz**
Pad Descriptions

| Pad Number | Function | Description | Pin Schematic |
|------------|----------|---|--|
| 1 | RFIN | This pad is DC coupled and matched to 50 Ohms |  |
| 2 | RFOUT | This pad is DC coupled and matched to 50 Ohms |  |
| 3 | Vctrl1 | Control Voltage 1 |  |
| 4 | Vctrl2 | Control Voltage 2 |  |
| Die Bottom | GND | Die bottom must be connected to RF/DC ground |  |

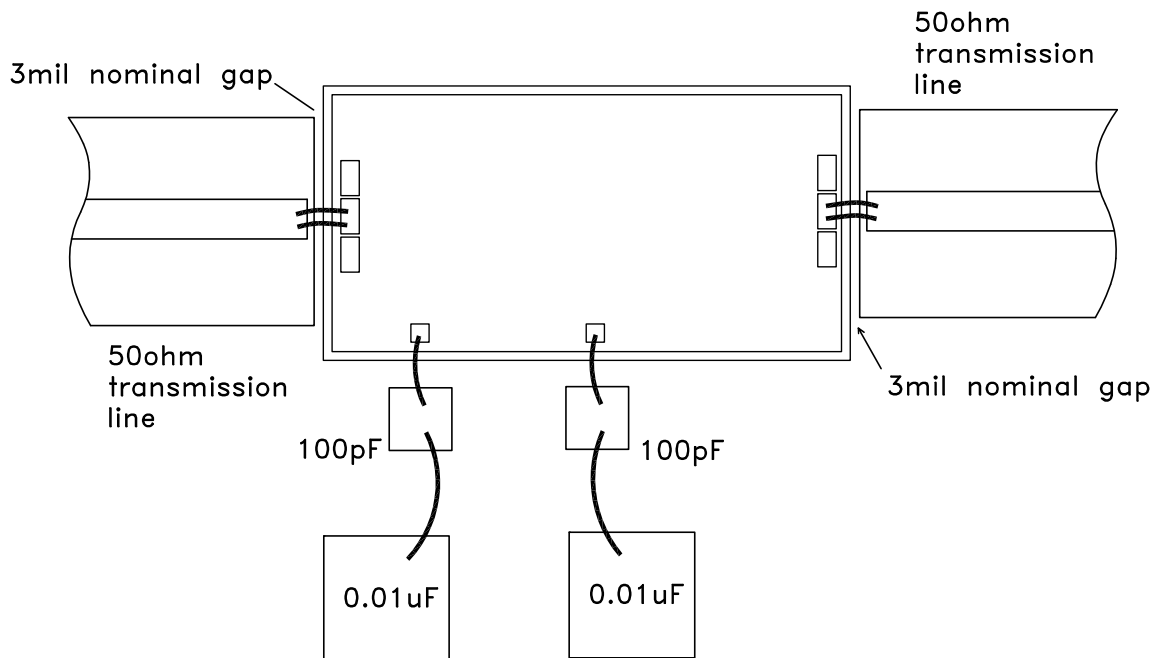
Assembly Diagram

GaAs MMIC VOLTAGE - VARIABLE ATTENUATOR, 20 - 50 GHz

Mounting & Bonding Techniques for Millimeterwave GaAs MMICs

The die should be attached directly to the ground plane eutectically or with conductive epoxy (see HMC general Handling, Mounting, Bonding Note).

50 Ohm Microstrip transmission lines on 0.127 mm (5 mil) thick alumina thin film substrates are recommended for bringing RF to and from the chip (Figure 1). If 0.254 mm (10 mil) thick alumina thin film substrates must be used, the die should be raised 0.150 mm (6 mils) so that the surface of the die is coplanar with the surface of the substrate. One way to accomplish this is to attach the 0.102 mm (4 mil) thick die to a 0.150 mm (6 mil) thick molybdenum heat spreader (moly-tab) which is then attached to the ground plane (Figure 2).

Microstrip substrates should be located as close to the die as possible in order to minimize bond wire length. Typical die-to-substrate spacing is 0.076 mm to 0.152 mm (3 to 6 mils).

Handling Precautions

Follow these precautions to avoid permanent damage.

Storage: All bare die are placed in either Waffle or Gel based ESD protective containers, and then sealed in an ESD protective bag for shipment. Once the sealed ESD protective bag has been opened, all die should be stored in a dry nitrogen environment.

Cleanliness: Handle the chips in a clean environment. DO NOT attempt to clean the chip using liquid cleaning systems.

Static Sensitivity: Follow ESD precautions to protect against $> \pm 250V$ ESD strikes.

Transients: Suppress instrument and bias supply transients while bias is applied. Use shielded signal and bias cables to minimize inductive pick-up.

General Handling: Handle the chip along the edges with a vacuum collet or with a sharp pair of bent tweezers. The surface of the chip may have fragile air bridges and should not be touched with vacuum collet, tweezers, or fingers.

Mounting

The chip is back-metallized and can be die mounted with AuSn eutectic preforms or with electrically conductive epoxy. The mounting surface should be clean and flat.

Eutectic Die Attach: A 80/20 gold tin preform is recommended with a work surface temperature of 255 °C and a tool temperature of 265 °C. When hot 90/10 nitrogen/hydrogen gas is applied, tool tip temperature should be 290 °C. DO NOT expose the chip to a temperature greater than 320 °C for more than 20 seconds. No more than 3 seconds of scrubbing should be required for attachment.

Epoxy Die Attach: Apply a minimum amount of epoxy to the mounting surface so that a thin epoxy fillet is observed around the perimeter of the chip once it is placed into position. Cure epoxy per the manufacturer's schedule.

Wire Bonding

Ball or wedge bond with 0.025 mm (1 mil) diameter pure gold wire. Thermosonic wirebonding with a nominal stage temperature of 150 °C and a ball bonding force of 40 to 50 grams or wedge bonding force of 18 to 22 grams is recommended. Use the minimum level of ultrasonic energy to achieve reliable wirebonds. Wirebonds should be started on the chip and terminated on the package or substrate. All bonds should be as short as possible < 0.31 mm (12 mils).

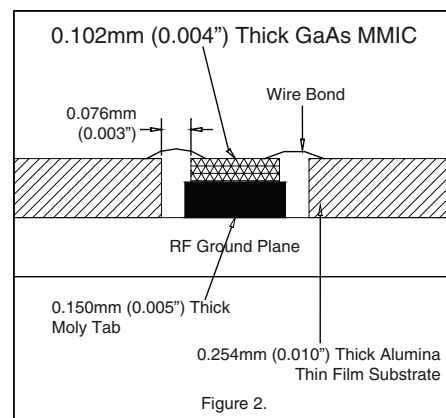
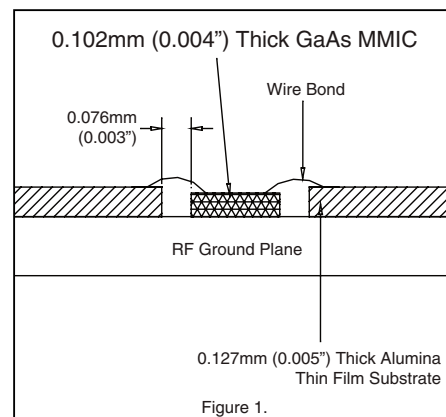

**GaAs MMIC VOLTAGE - VARIABLE
ATTENUATOR, 20 - 50 GHz**

Notes: