



SMT GaAs HBT MMIC x4 ACTIVE FREQUENCY MULTIPLIER, 9.8 - 11.2 GHz OUTPUT

Typical Applications

Active Multiplier for X Band Applications:

- Fiber Optic
- Point-to-Point Radios
- Military Radar

Features

- Output Power: +4 dBm
- Sub-Harmonic Suppression: >25 dBc
- SSB Phase Noise: -142 dBc/Hz
- Single Supply: 5V@ 52 mA
- 24 Lead 4x4 mm SMT Package: 16 mm²

Functional Diagram

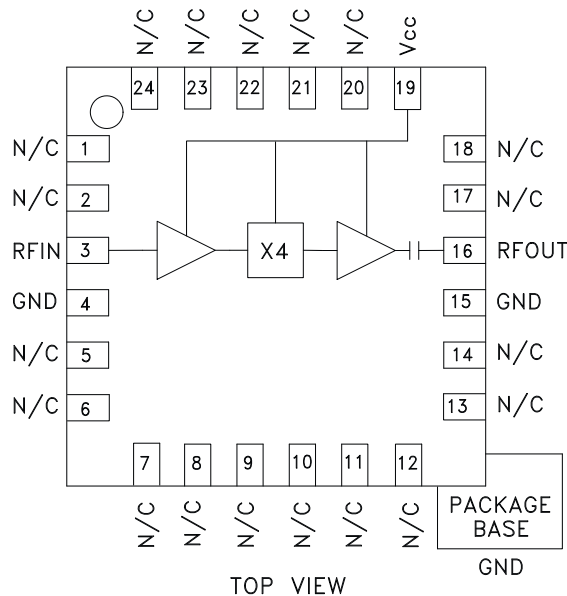

General Description

The HMC443LP4 & HMC443LP4E are active miniature x4 frequency multipliers utilizing InGaP GaAs HBT technology in 4x4 mm leadless surface mount packages. Power output is +4 dBm typical from a 5V supply voltage and varies little vs. input power, temperature and supply voltage. Suppression of undesired fundamental and sub-harmonics is >25 dBc typical with respect to output signal level. The low additive SSB phase noise of -142 dBc/Hz at 100 kHz offset helps the user maintain good system noise performance. The HMC443LP4 & HMC443LP4E are ideal for use in LO multiplier chains allowing reduced parts count vs. traditional approaches.

Electrical Specifications, $T_A = +25^\circ C$, $V_{cc} = 5V$

Parameter	Min.	Typ.	Max.	Units
Frequency Range, Input	2.45 - 2.80			GHz
Frequency Range, Output	9.8 - 11.2			GHz
Input Power Range	-15		+5	dBm
Output Power	1	4		dBm
Sub-Harmonic Suppression		25		dBc
Input Return Loss		15		dB
Output Return Loss		8		dB
SSB Phase Noise (100 kHz Offset)	Pin= 0 dBm		-142	dBc/Hz
Supply Current (Icc)		52	69	mA



SMT GaAs HBT MMIC x4 ACTIVE FREQUENCY MULTIPLIER, 9.8 - 11.2 GHz OUTPUT

Output Power vs. Temperature @ -10 dBm Drive Level

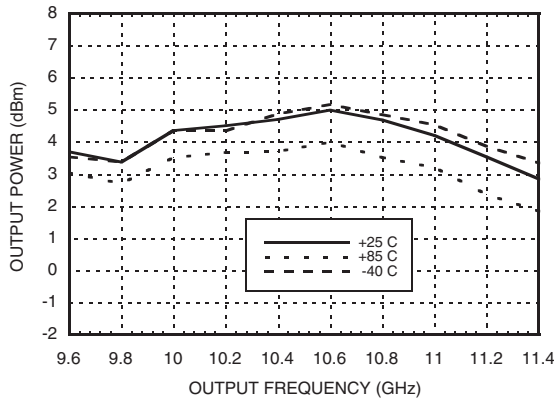

Output Power vs. Drive Level

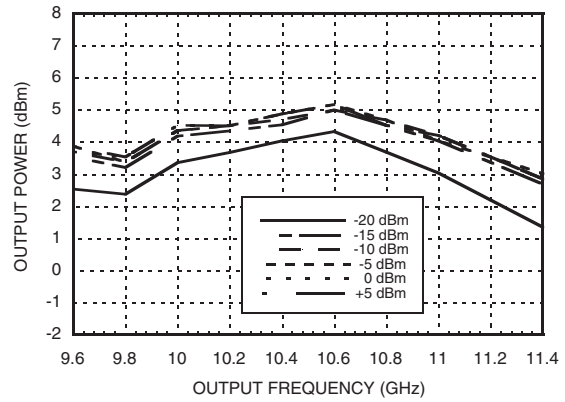

Output Power vs. Supply Voltage @ -10 dBm Drive Level

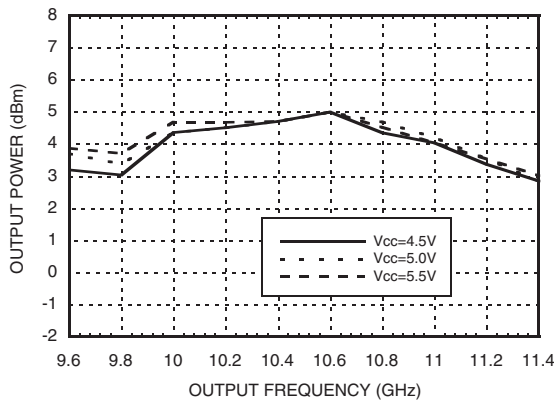

Input Return Loss vs. Temperature

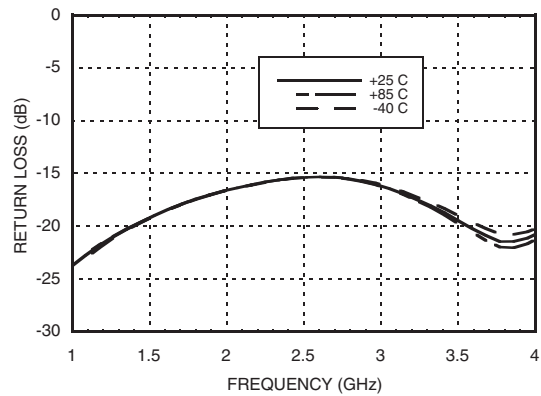

Output Return Loss vs. Temperature

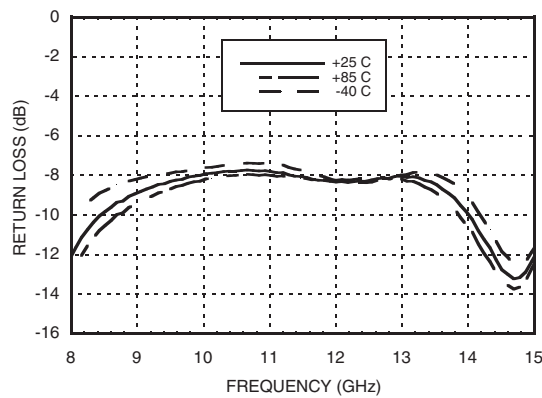



**SMT GaAs HBT MMIC x4 ACTIVE
FREQUENCY MULTIPLIER, 9.8 - 11.2 GHz OUTPUT**

Output Spectrum

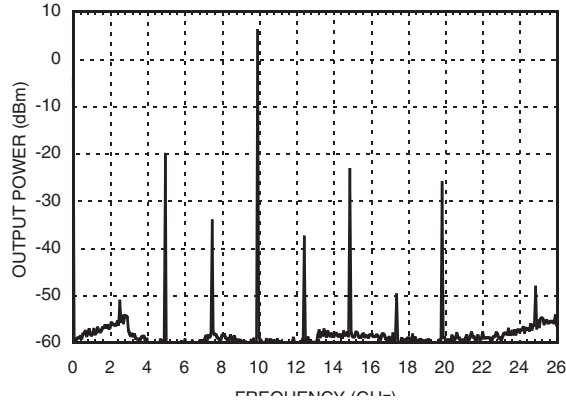

**SSB Phase Noise
Performance, Fout= 10.5 GHz**

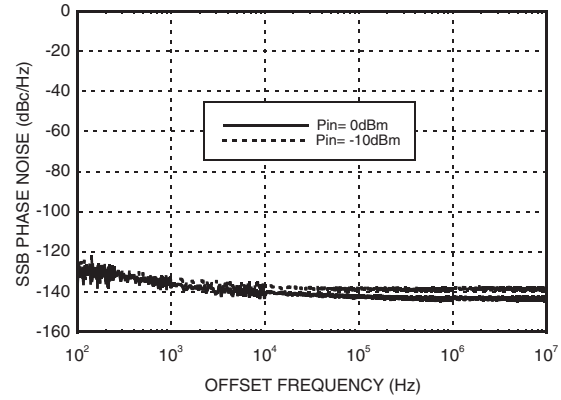

SMT GaAs HBT MMIC x4 ACTIVE FREQUENCY MULTIPLIER, 9.8 - 11.2 GHz OUTPUT

Absolute Maximum Ratings

RF Input (Vcc = +5V)	+20 dBm
Vcc	+5.5V
Channel Temperature	135 °C
Continuous Pdiss (T=85 °C) (derate 7.6 mW/°C above 85 °C)	500 mW
Thermal Resistance (R _{thj}) (junction to ground paddle)	130.8 °C/W
Storage Temperature	-65 to +150 °C
Operating Temperature	-40 to +85 °C

Typical Supply Current vs. Vcc

Vcc (V)	Icc (mA)
4.5	51
5.0	52
5.5	54

Note: Multiplier will operate over full voltage range shown above.



ELECTROSTATIC SENSITIVE DEVICE
OBSERVE HANDLING PRECAUTIONS

Outline Drawing

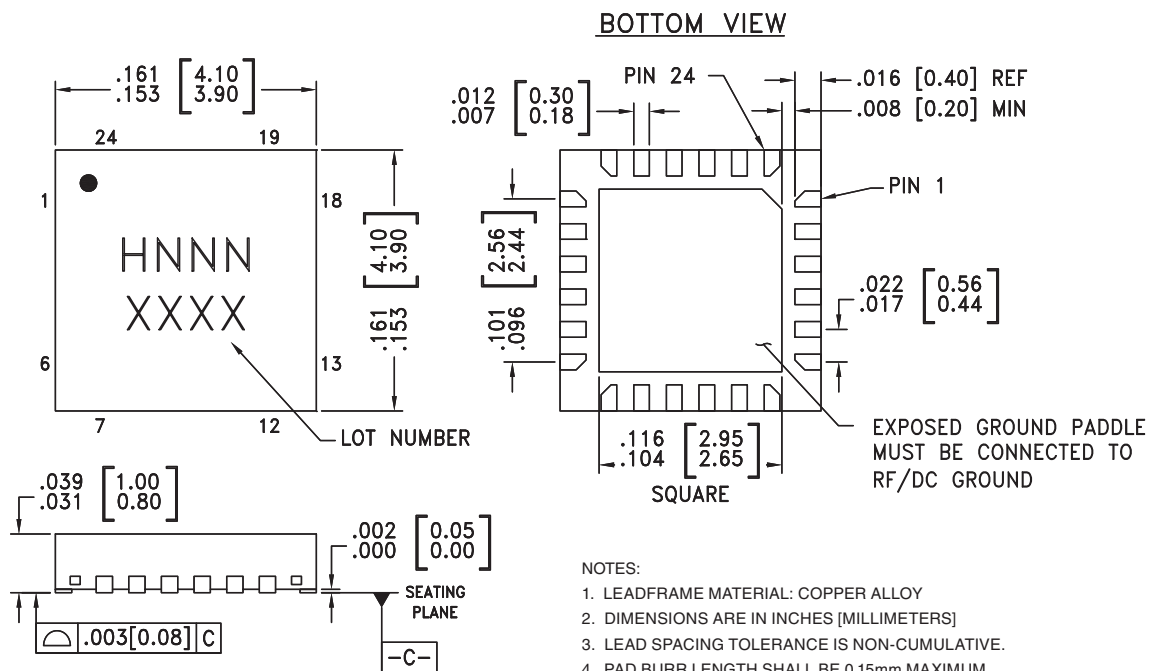

Package Information

Part Number	Package Body Material	Lead Finish	MSL Rating	Package Marking ^[3]
HMC443LP4	Low Stress Injection Molded Plastic	Sn/Pb Solder	MSL1 ^[1]	H443 XXXX
HMC443LP4E	RoHS-compliant Low Stress Injection Molded Plastic	100% matte Sn	MSL1 ^[2]	H443 XXXX

[1] Max peak reflow temperature of 235 °C



[2] Max peak reflow temperature of 260 °C

[3] 4-Digit lot number XXXX

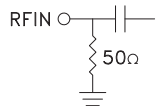

**SMT GaAs HBT MMIC x4 ACTIVE
FREQUENCY MULTIPLIER, 9.8 - 11.2 GHz OUTPUT**

Pin Description

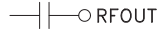
Pin Number	Function	Description	Interface Schematic
1, 2, 5 - 14, 17, 18, 20 - 24	N/C	The pins are not connected internally; however, all data shown herein was measured with these pins connected to RF/DC ground externally.	
3	RFIN	RF input needs to be DC blocked only if there is an external DC voltage applied to RF IN.	
4, 15	GND	All ground leads and ground paddle must be soldered to PCB RF/DC ground.	
16	RFOUT	Multiplied Output. AC coupled. No external DC blocks necessary.	
19	Vcc	Supply voltage 5V ± 0.5V.	



Evaluation PCB

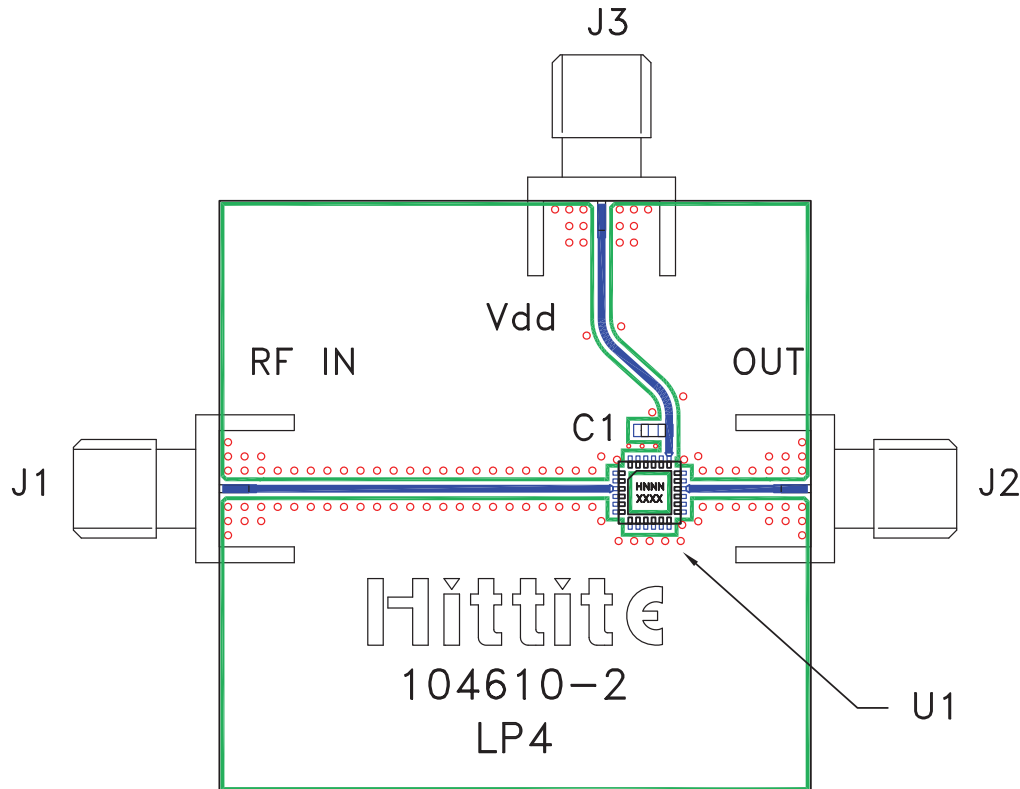

List of Materials for Evaluation PCB 106137 [1]

Item	Description
J1 - J3	PCB Mount SMA Connector
C1	1,000 pF Capacitor, 0603 Pkg.
U1	HMC443LP4 / HMC443LP4E x4 Active Multiplier
PCB [2]	104610 Eval Board

[1] Reference this number when ordering complete evaluation PCB

[2] Circuit Board Material: Rogers 4350

The circuit board used in the final application should be generated with proper RF circuit design techniques. Signal lines should have 50 ohm impedance while the package ground leads and exposed paddle should be connected directly to the ground plane similar to that shown. The evaluation circuit board shown is available from Hittite upon request.