

GaAs MMIC VOLTAGE-VARIABLE ATTENUATOR, DC - 18 GHz

Typical Applications

The HMC346LC3B is ideal for:

- Test Instrumentation
- Fiber Optics & Broadband Telecom
- Microwave Radio & VSAT
- Military Radios, Radar, & ECM

Features

- Wide Bandwidth: DC - 18 GHz
- Low Phase Shift vs. Attenuation
- 30 dB Attenuation Range
- Simplified Voltage Control
- RoHS Compliant 3 x 3 mm SMT Package

Functional Diagram

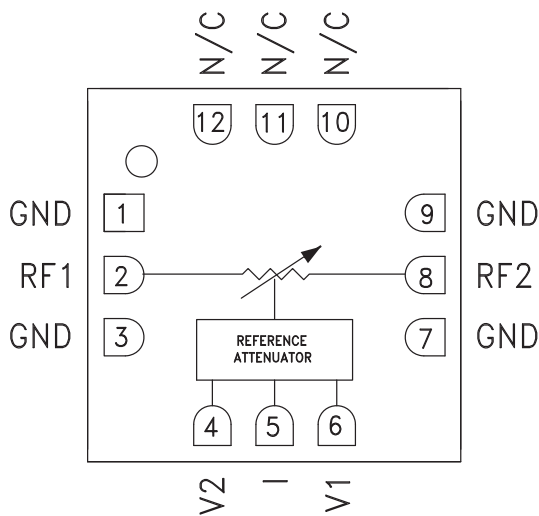

General Description

The HMC346LC3B is an absorptive Voltage Variable Attenuator (VVA) in a leadless “Pb free” RoHS compliant SMT mount ceramic package operating from DC - 18 GHz. It features an on-chip reference attenuator for use with an external op-amp to provide simple single voltage attenuation control, 0 to -3V. The device is ideal in designs where an analog DC control signal must control RF signal levels over a 30 dB amplitude range. The HMC346LC3B allows the use of surface mount manufacturing techniques.

Electrical Specifications, $T_A = +25^\circ\text{C}$, 50 Ohm system

Parameter	Min	Typical	Max	Units
Insertion Loss	DC - 10 GHz	1.5	2.0	dB
	DC - 14 GHz	2.2	2.7	dB
	DC - 18 GHz	2.8	3.5	dB
Attenuation Range	DC - 12 GHz	26	30	dB
	DC - 18 GHz	22	26	dB
Return Loss	DC - 18 GHz	10		dB
Input Power for 0.25 dB Compression (0.5 - 18 GHz)	Min. Atten:	+8		dBm
	Atten. >2 dB:	-4		dBm
Input Third Order Intercept (0.5 - 18 GHz) (Two-tone Input Power = -8 dBm Each Tone)	Min. Atten:	+25		dBm
	Atten. >2 dB:	+10		dBm
Switching Characteristics	tRISE, tFALL (10/90% RF):	2		ns
	tON, tOFF (50% CTL to 10/90% RF):	8		ns

GaAs MMIC VOLTAGE-VARIABLE ATTENUATOR, DC - 18 GHz

Insertion Loss vs. Temperature

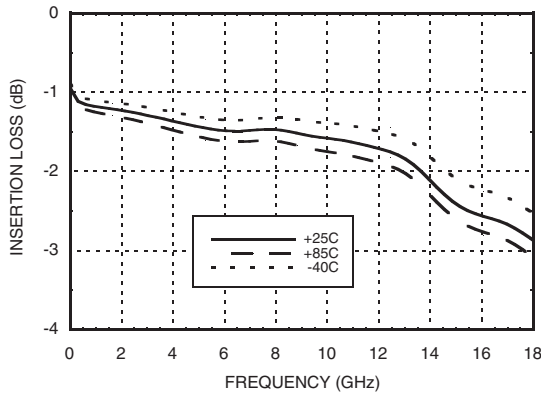

Relative Attenuation

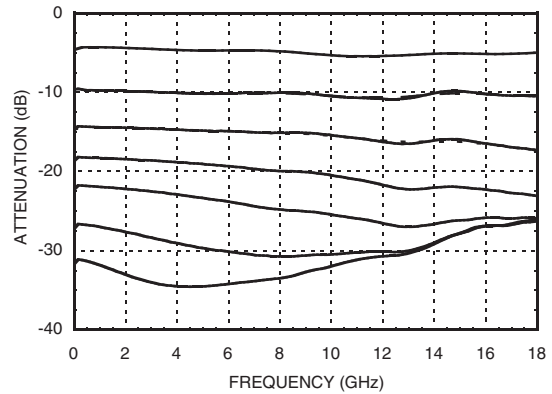

Return Loss vs. Attenuation

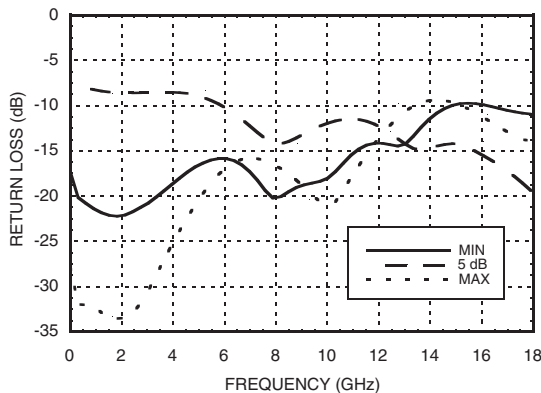

Relative Attenuation vs. Control Voltage @ 10 GHz

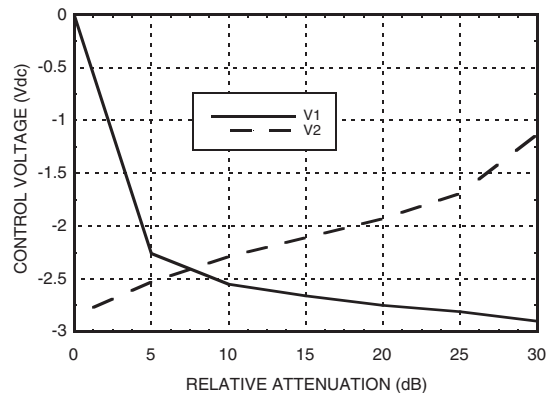

Relative Phase vs. Attenuation

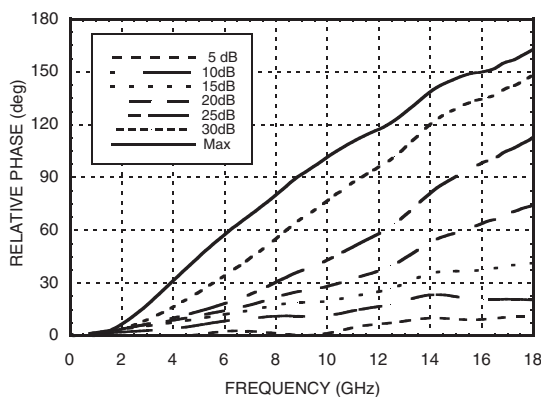

Input IP3 vs. Attenuation*

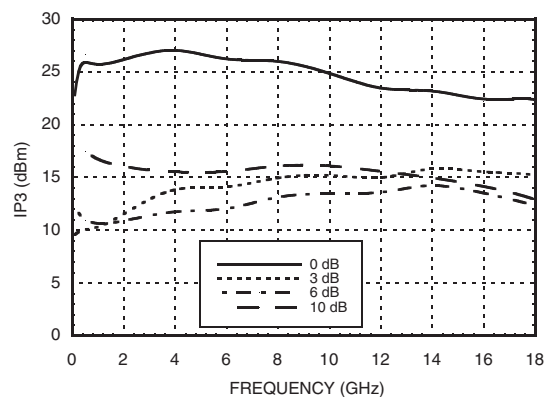

*Two-tone input power = -8 dBm each tone, 1 MHz spacing.



**GaAs MMIC VOLTAGE-VARIABLE
ATTENUATOR, DC - 18 GHz**

5

ATTENUATORS - ANALOG - SMT

**Second Harmonic
vs. Attenuation, Pin = -8 dBm**

Input IP2 vs. Attenuation*

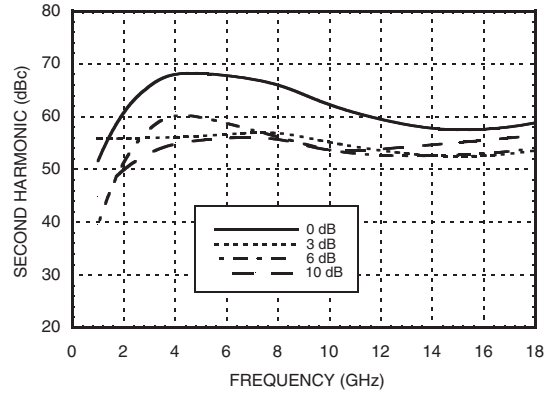
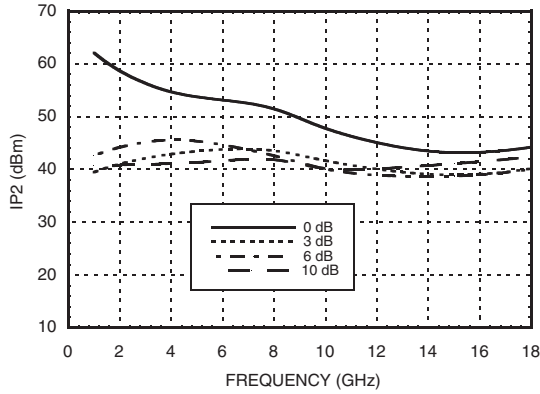

0.25 dB Compression vs. Attenuation

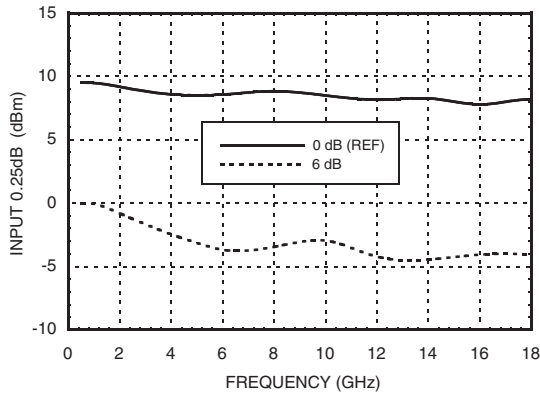

1 dB Compression vs. Attenuation

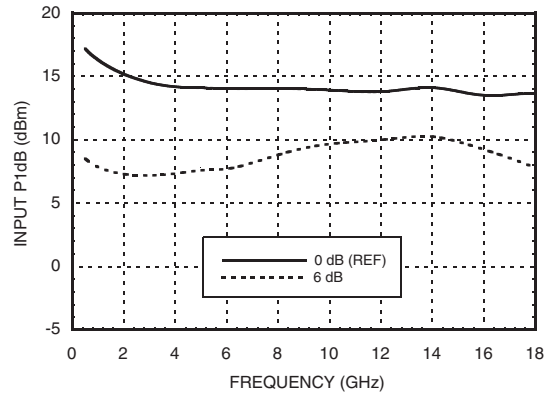

*Two-tone input power = -8 dBm each tone, 1 MHz spacing.



GaAs MMIC VOLTAGE-VARIABLE ATTENUATOR, DC - 18 GHz

Absolute Maximum Ratings

RF Input Power	+18 dBm
Control Voltage Range	+1 to -5V
Storage Temperature	-65 to +150 °C
Operating Temperature	-40 to +85 °C
ESD Sensitivity (HBM)	Class 1A



ELECTROSTATIC SENSITIVE DEVICE
OBSERVE HANDLING PRECAUTIONS

Outline Drawing

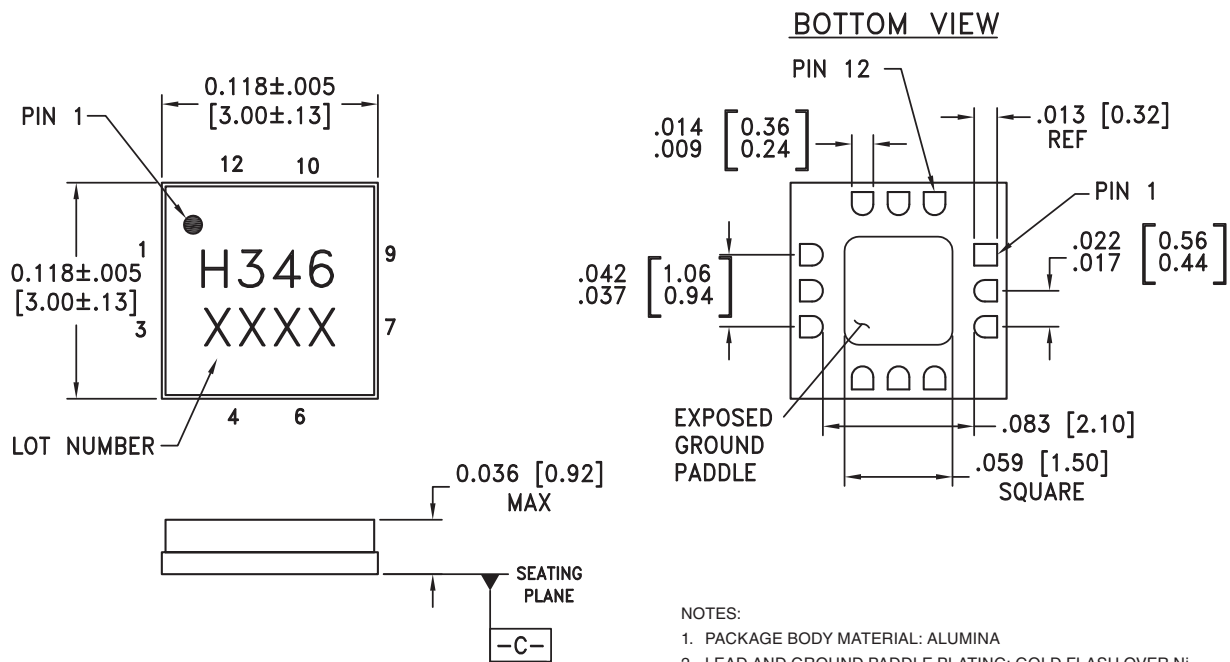





**GaAs MMIC VOLTAGE-VARIABLE
ATTENUATOR, DC - 18 GHz**

5

ATTENUATORS - ANALOG - SMT

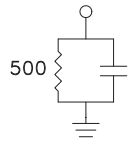
Pin Descriptions

Pin Number	Function	Description	Interface Schematic
1, 3, 7, 9	GND	Package bottom has exposed metal paddle that must also be connected to PCB RF ground.	
2, 8	RF1 RF2	This pin is DC coupled and matched to 50 Ohm. Blocking capacitors are required if the RF line potential is not equal to 0V.	
4, 6	V2, V1	Control input (master).	
5	I	Control input (slave).	
10, 11, 12	N/C	This pin may be connected to PCB RF/DC ground. Performance will not be affected.	

Single-Line Control Driver

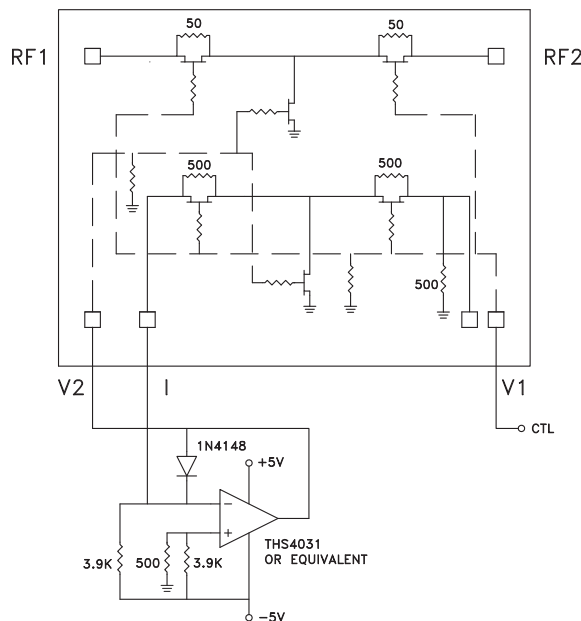

External op-amp control circuit maintains impedance match while attenuation is varied. Input control ranges from 0 Volts (min. attenuation) to -3.0 Volts (max. attenuation.)

For price, delivery, and to place orders, please contact Hittite Microwave Corporation:
20 Alpha Road, Chelmsford, MA 01824 Phone: 978-250-3343 Fax: 978-250-3373
Order On-line at www.hittite.com

Evaluation PCB

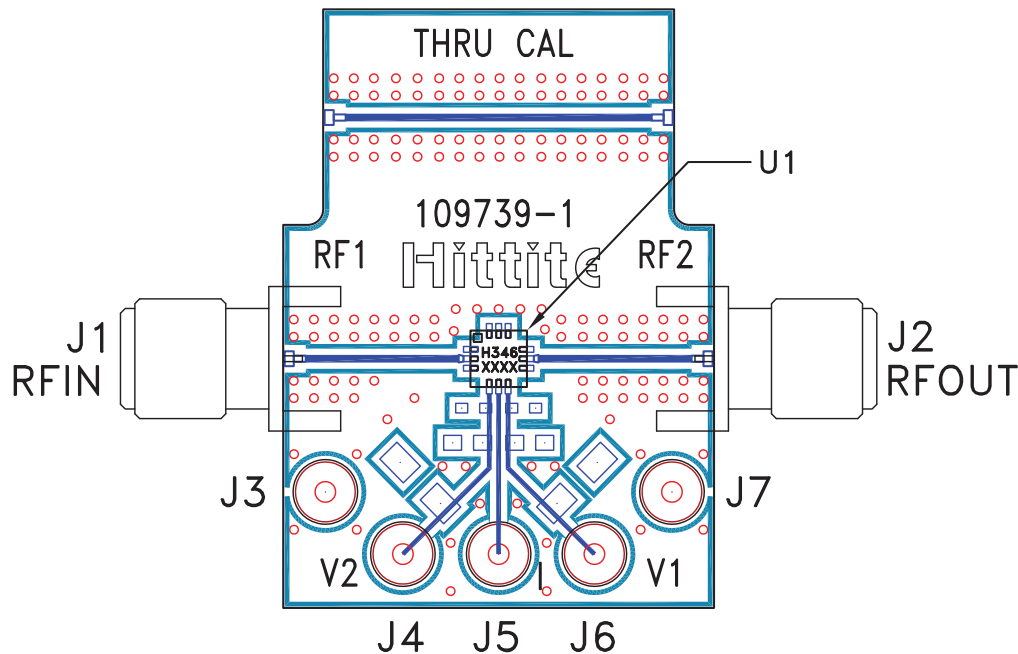

List of Materials for Evaluation PCB 109741 ^[1]

Item	Description
J1 - J2	PCB Mount SMA RF Connector
J3 - J7	DC Pin
U1	HMC346LC3B VVA
PCB [2]	109739-1 Evaluation PCB

[1] Reference this number when ordering complete evaluation PCB

[2] Circuit Board Material: Rogers 4350

The circuit board used in the final application should be generated with proper RF circuit design techniques. Signal lines at the RF ports should be 50 ohm impedance and the package ground leads and package bottom should be connected directly to the PCB RF ground plane, similar to that shown above. The evaluation circuit board shown above is available from Hittite Microwave Corporation upon request.