

GaAs MMIC PASSIVE FREQUENCY DOUBLER, 12 - 18 GHz INPUT

Typical Applications

The HMC331 is suitable for:

- Wireless Local Loop
- LMDS, VSAT, and Point-to-Point Radios
- Test Equipment

Features

- Conversion Loss: 14 dB
- Fo, 3Fo, 4Fo Isolation: 50 dB
- Passive: No Bias Required
- Die Size: 0.85 x 0.55 x 0.1 mm

Functional Diagram

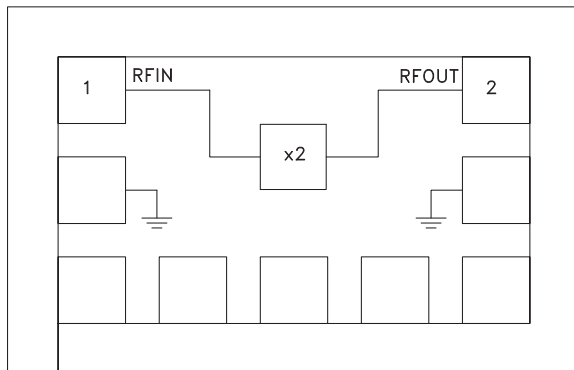

General Description

The HMC331 is a passive miniature frequency doubler MMIC. Suppression of undesired fundamental and higher order harmonics is 50 dB typical with respect to input signal level. The doubler utilizes the same GaAs Schottky diode/balun technology found in Hittite MMIC mixers. It features small size, requires no DC bias, and adds no measurable additive phase noise onto the multiplied signal.

Electrical Specifications, $T_A = +25^\circ \text{C}$, As a Function of Drive Level

Parameter	Input = +11 dBm			Input = +13 dBm			Input = +15 dBm			Units
	Min.	Typ.	Max.	Min.	Typ.	Max.	Min.	Typ.	Max.	
Frequency Range, Input	13 - 18			12 - 18			12 - 18			GHz
Frequency Range, Output	26 - 36			24 - 36			24 - 36			GHz
Conversion Loss		15	20		14	20		14	19	dB
FO Isolation (with respect to input level)	45	50		45	50		45	50		dB
3FO Isolation (with respect to input level)	50	60		45	60		47	60		dB
4FO Isolation (with respect to input level)	50	60		50	60		50	60		dB

GaAs MMIC PASSIVE FREQUENCY DOUBLER, 12 - 18 GHz INPUT

Conversion Loss vs. Temperature @ +15 dBm Drive Level

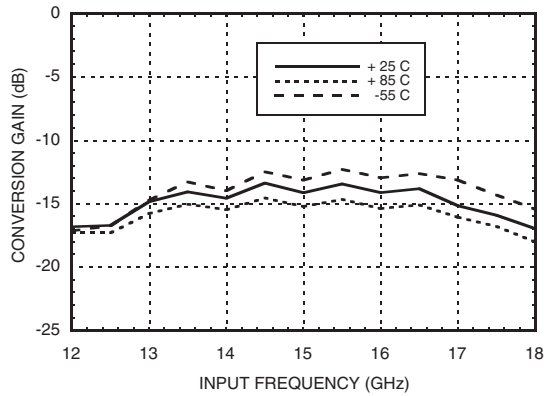

Conversion Loss @ 25 C Vs. Drive Level

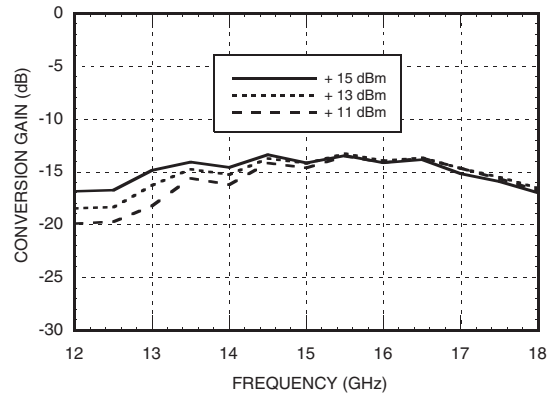

Isolation @ +15 dBm Drive Level*

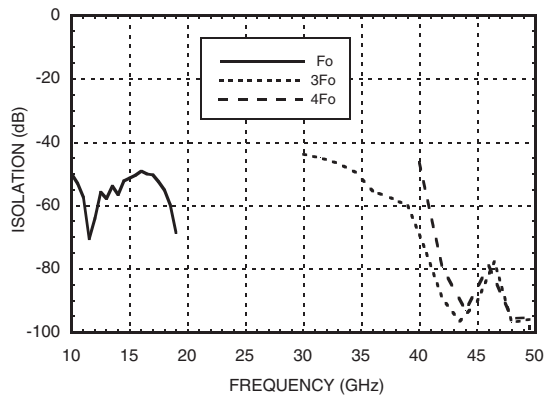

*With respect to input level

Input Return Loss vs. Drive Level

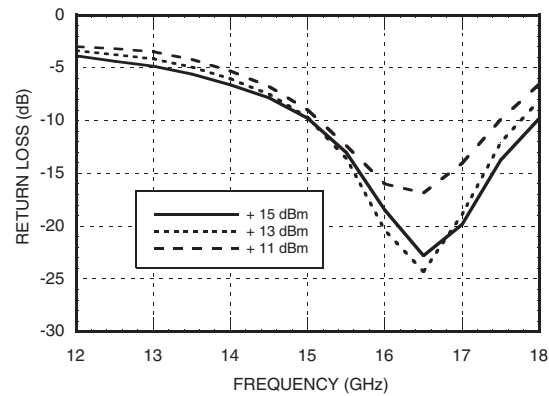

Output Return Loss For Three Input Frequencies

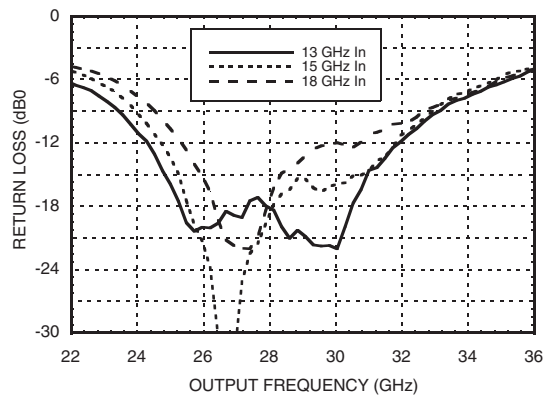

Absolute Maximum Ratings

Input Drive	+27 dBm
Storage Temperature	-65 to +150 °C
Operating Temperature	-55 to +85 °C



**ELECTROSTATIC SENSITIVE DEVICE
OBSERVE HANDLING PRECAUTIONS**

GaAs MMIC PASSIVE FREQUENCY DOUBLER, 12 - 18 GHz INPUT

Outline Drawing

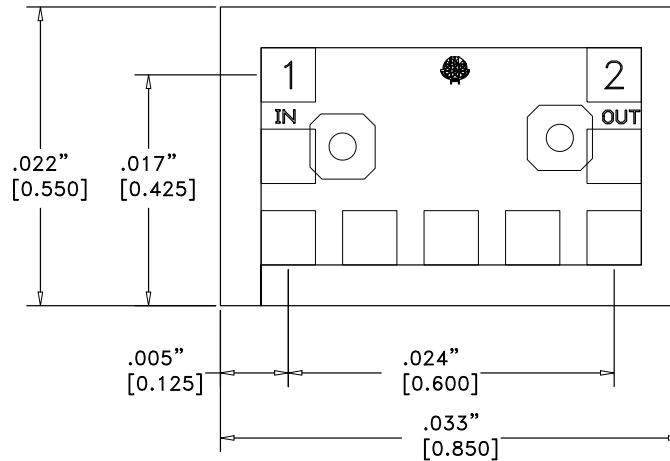

Die Packaging Information [1]



Standard	Alternate
GP-5 (Gel Pack)	[2]

[1] Refer to the "Packaging Information" section for die packaging dimensions.
[2] For alternate packaging information contact Hittite Microwave Corporation.

NOTES:

1. ALL DIMENSIONS ARE IN INCHES [MM]
2. DIE THICKNESS IS .004"
3. TYPICAL BOND IS .004" SQUARE
4. BACKSIDE METALLIZATION: GOLD
5. BOND PAD METALLIZATION: GOLD
6. BACKSIDE METAL IS GROUND.
7. CONNECTION NOT REQUIRED FOR UNLABELED BOND PADS.

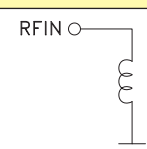
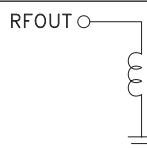
Pad Description

Pad Number	Function	Description	Interface Schematic
1	RFIN	DC coupled and matched to 50 Ohm.	
2	RFOUT	DC coupled and matched to 50 Ohm.	
Die Bottom	GND	Die bottom must be connected to RF/DC ground.	

GaAs MMIC PASSIVE FREQUENCY DOUBLER, 12 - 18 GHz INPUT

Mounting & Bonding Techniques for Millimeterwave GaAs MMICs

The die should be attached directly to the ground plane eutectically or with conductive epoxy (see HMC general Handling, Mounting, Bonding Note).

50 Ohm Microstrip transmission lines on 0.127mm (5 mil) thick alumina thin film substrates are recommended for bringing RF to and from the chip (Figure 1). If 0.254mm (10 mil) thick alumina thin film substrates must be used, the die should be raised 0.150mm (6 mils) so that the surface of the die is coplanar with the surface of the substrate. One way to accomplish this is to attach the 0.102mm (4 mil) thick die to a 0.150mm (6 mil) thick molybdenum heat spreader (moly-tab) which is then attached to the ground plane (Figure 2).

Microstrip substrate should be brought as close to the die as possible in order to minimize ribbon bond length. Typical die-to-substrate spacing is 0.076mm (3 mils). Gold ribbon of 0.075mm (3 mil) width and minimal length <0.31mm (<12 mils) is recommended to minimize inductance on RF ports.

Handling Precautions

Follow these precautions to avoid permanent damage.

Storage: All bare die are placed in either Waffle or Gel based ESD protective containers, and then sealed in an ESD protective bag for shipment. Once the sealed ESD protective bag has been opened, all die should be stored in a dry nitrogen environment.

Cleanliness: Handle the chips in a clean environment. DO NOT attempt to clean the chip using liquid cleaning systems.

Static Sensitivity: Follow ESD precautions to protect against ESD strikes.

Transients: Suppress instrument and bias supply transients while bias is applied. Use shielded signal and bias cables to minimize inductive pick-up.

General Handling: Handle the chip along the edges with a vacuum collet or with a sharp pair of bent tweezers. The surface of the chip may have fragile air bridges and should not be touched with vacuum collet, tweezers, or fingers.

Mounting

The chip is back-metallized and can be die mounted with AuSn eutectic preforms or with electrically conductive epoxy. The mounting surface should be clean and flat.

Eutectic Die Attach: A 80/20 gold tin preform is recommended with a work surface temperature of 255 °C and a tool temperature of 265 °C. When hot 90/10 nitrogen/hydrogen gas is applied, tool tip temperature should be 290 °C. DO NOT expose the chip to a temperature greater than 320 °C for more than 20 seconds. No more than 3 seconds of scrubbing should be required for attachment.

Epoxy Die Attach: Apply a minimum amount of epoxy to the mounting surface so that a thin epoxy fillet is observed around the perimeter of the chip once it is placed into position. Cure epoxy per the manufacturer's schedule.

Wire Bonding

RF bonds made with 0.003" x 0.0005" ribbon are recommended. These bonds should be thermosonically bonded with a force of 40 - 60 grams. DC bonds of 0.001" (0.025mm) diameter, thermosonically bonded, are recommended. Ball bonds should be made with a force of 40 - 50 grams and wedge bonds at 18 - 22 grams. All bonds should be made with a nominal stage temperature of 150 °C. A minimum amount of ultrasonic energy should be applied to achieve reliable bonds. All bonds should be as short as possible, less than 12 mils (0.31 mm).

