



GaAs MMIC SMT PASSIVE FREQUENCY DOUBLER, 4 - 8 GHz INPUT

Typical Applications

The HMC204C8 is suitable for:

- Wireless Local Loop
- LMDS, VSAT, and Point-to-Point Radios
- Test Equipment

Features

- Conversion Loss: 16 dB
- Fo, 3Fo, 4Fo Isolation: 40 dB
- Passive: No Bias Required

Functional Diagram

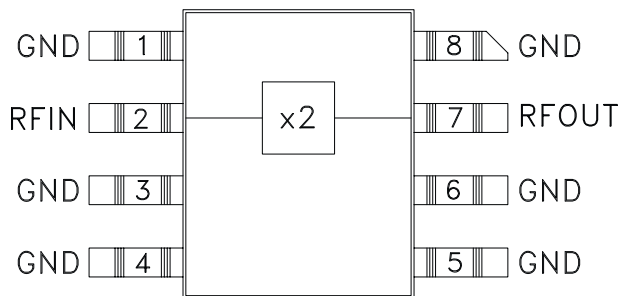

General Description

The HMC204C8 is a passive miniature frequency doubler in a non-hermetic surface mount package. Suppression of undesired fundamental and higher order harmonics is 40 dB typical with respect to input signal level. The doubler utilizes the same GaAs Schottky diode/balun technology found in Hittite MMIC mixers. It features small size, no DC bias, and no measurable additive phase noise onto the multiplied signal.

Electrical Specifications, $T_A = +25^\circ \text{C}$, As a Function of Drive Level

| Parameter | Input = +10 dBm | | | Input = +13 dBm | | | Input = +15 dBm | | | Units |
|--|-----------------|------|------|-----------------|------|------|-----------------|------|------|-------|
| | Min. | Typ. | Max. | Min. | Typ. | Max. | Min. | Typ. | Max. | |
| Frequency Range, Input | 5.5 - 7.5 | | | 5.0 - 8.0 | | | 4.0 - 8.0 | | | GHz |
| Frequency Range, Output | 11.0 - 15.0 | | | 10.0 - 16.0 | | | 8.0 - 16.0 | | | GHz |
| Conversion Loss | | 16 | 19 | | 16 | 19 | | 16 | 19 | dB |
| FO Isolation (with respect to input level) | | | | 37 | 41 | | | | | dB |
| 3FO Isolation (with respect to input level) | | | | 42 | 46 | | | | | dB |
| 4FO Isolation (with respect to input level) | | | | 35 | 40 | | | | | dB |



GaAs MMIC SMT PASSIVE FREQUENCY DOUBLER, 4 - 8 GHz INPUT

Conversion Gain vs. Temperature @ +15 dBm Drive Level

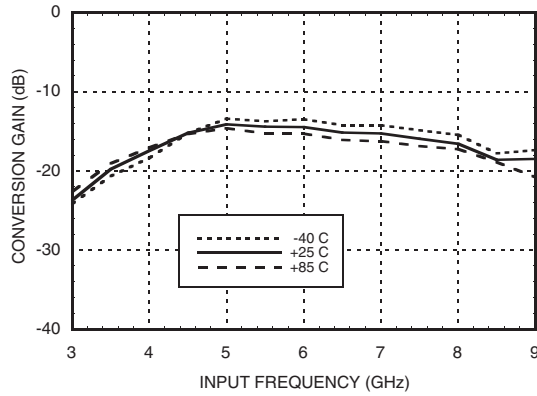

Isolation @ +15 dBm Drive Level*

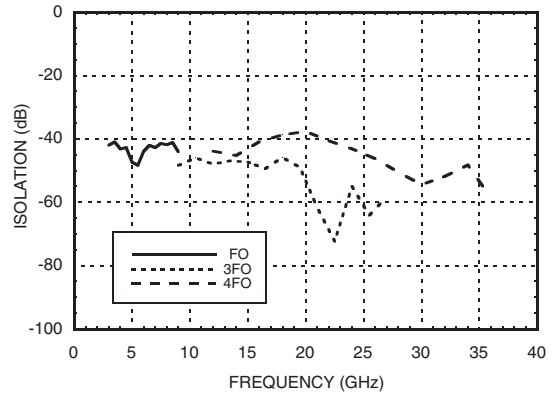

*With respect to input level

Input Return Loss vs. Drive Level

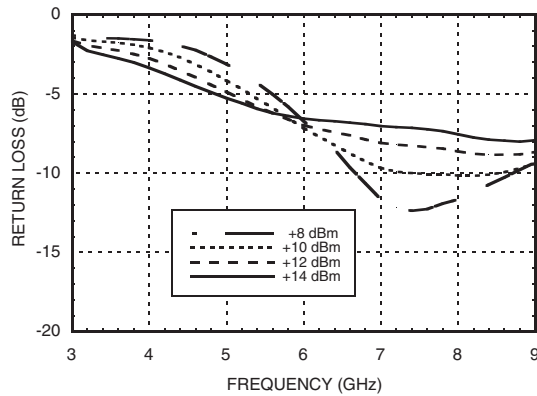

Output Return Loss for Several Input Frequencies

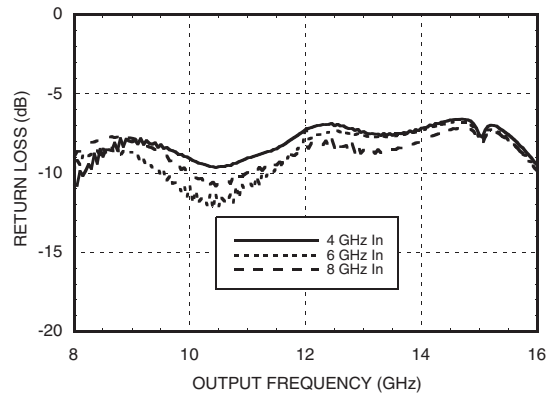



GaAs MMIC SMT PASSIVE FREQUENCY DOUBLER, 4 - 8 GHz INPUT

7

FREQ. MULTIPLIERS - PASSIVE - SMT

Conversion Gain @ 25 °C vs. Drive Level

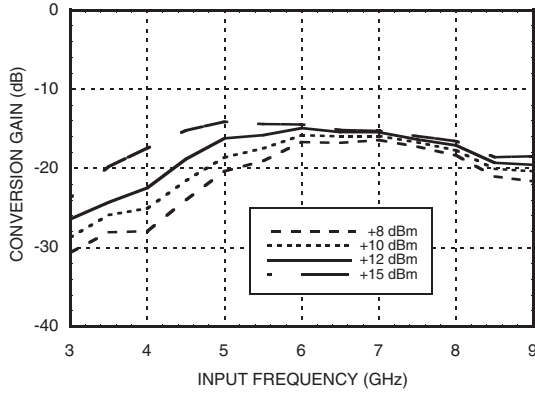

Output Return Loss with 4 GHz Input

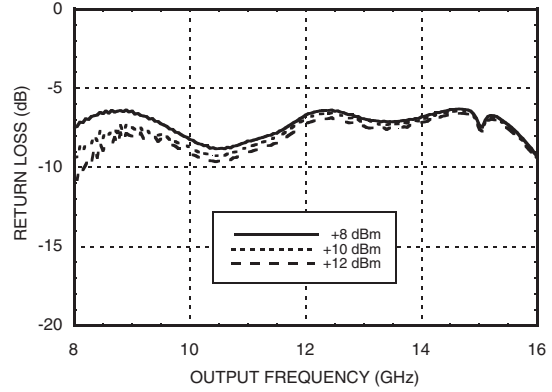

Conversion Gain @ -40 °C vs. Drive Level

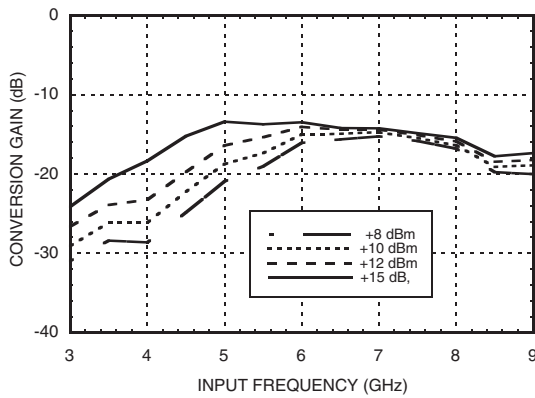

Output Return Loss with 6 GHz Input

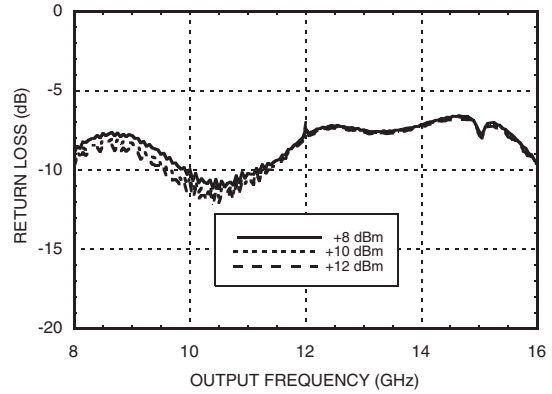

Conversion Gain @ +85 °C vs. Drive Level

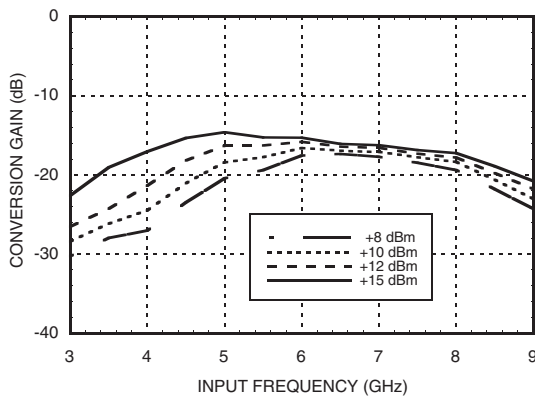

Output Return Loss with 8 GHz Input

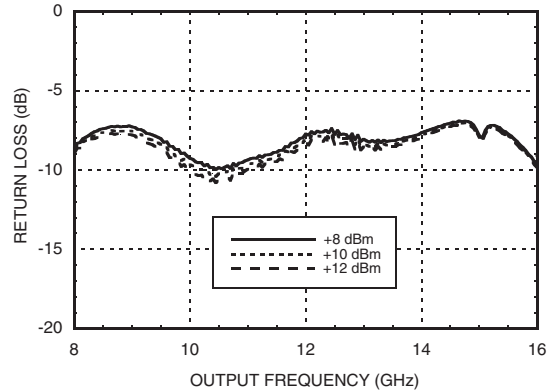



GaAs MMIC SMT PASSIVE FREQUENCY DOUBLER, 4 - 8 GHz INPUT

Absolute Maximum Ratings

| | |
|-----------------------|----------------|
| Input Drive | +27 dBm |
| Storage Temperature | -65 to +150 °C |
| Operating Temperature | -40 to +85 °C |



**ELECTROSTATIC SENSITIVE DEVICE
OBSERVE HANDLING PRECAUTIONS**

Outline Drawing

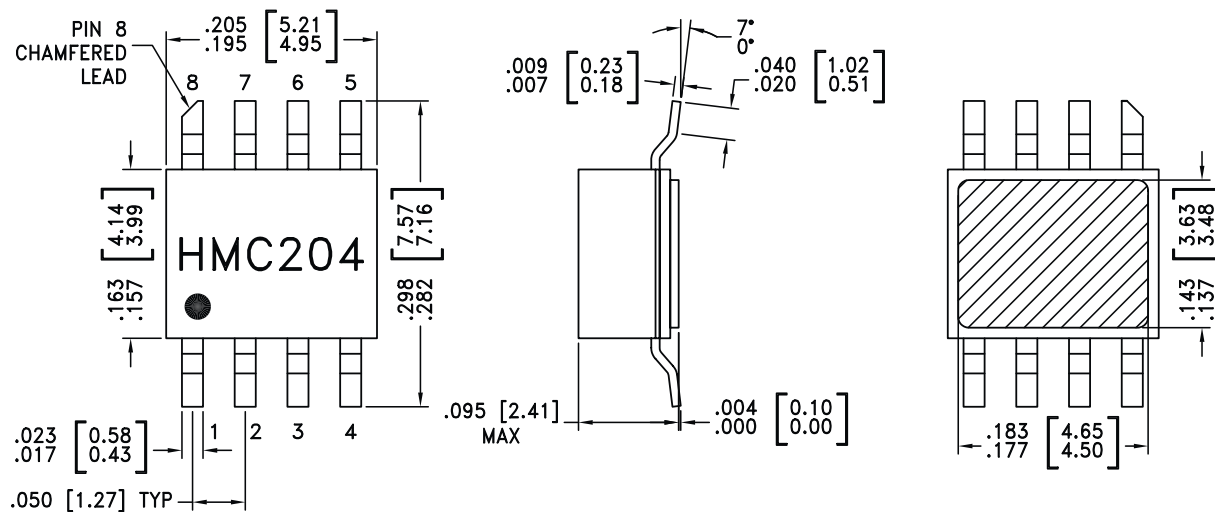

NOTES:

1. PACKAGE BODY MATERIAL: WHITE ALUMINA 92%
2. LEAD, PACKAGE BOTTOM MATERIAL: COPPER
3. PLATING: ELECTROLYTIC GOLD 100 - 200 MICROINCHES OVER ELECTROLYTIC NICKEL 100 TO 200 MICROINCHES.
4. DIMENSIONS ARE IN INCHES [MILLIMETERS].
5. PACKAGE LENGTH AND WIDTH DIMENSIONS DO NOT INCLUDE LID SEAL PROTRUSION .005 PER SIDE.
6. ALL GROUND LEADS AND GROUND PADDLE MUST BE SOLDERED TO PCB PF GROUND.



GaAs MMIC SMT PASSIVE FREQUENCY DOUBLER, 4 - 8 GHz INPUT

Evaluation PCB

7

FREQ. MULTIPLIERS - PASSIVE - SMT

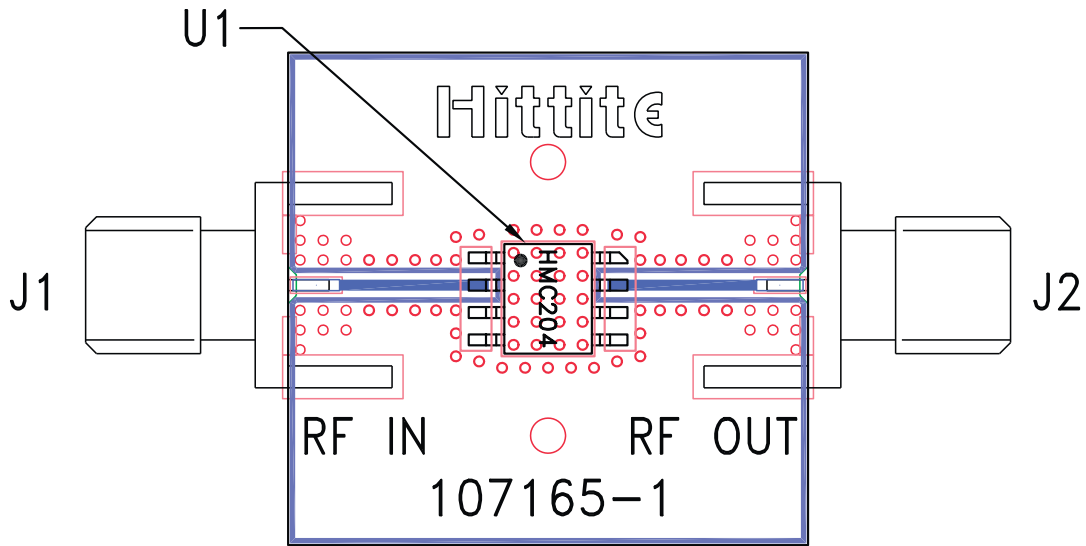

List of Materials for Evaluation PCB 107196 [1]

| Item | Description |
|---------|-------------------------|
| J1, J2 | PCB Mount SMA Connector |
| U1 | HMC204C8, Doubler |
| PCB [2] | 107165 Eval Board |

[1] Reference this number when ordering complete evaluation PCB

[2] Circuit Board Material: Rogers 4350

The circuit board used in the final application should be generated with proper RF circuit design techniques. Signal lines should have 50 ohm impedance while the package ground leads and exposed paddle should be connected directly to the ground plane similar to that shown. The evaluation circuit board shown is available from Hittite upon request.



MICROWAVE CORPORATION v04.1105



HMC204C8

**GaAs MMIC SMT PASSIVE FREQUENCY
DOUBLER, 4 - 8 GHz INPUT**

Notes:

7

FREQ. MULTIPLIERS - PASSIVE - SMT