

FEATURES

- ±600 V common-mode voltage range**
- Rail-to-rail output**
- Fixed gain of 1**
- Wide power supply range of ±2.5 V to ±18 V**
- 550 µA typical power supply current**
- Excellent ac specifications**
 - 90 dB minimum CMRR**
 - 130 kHz bandwidth**
- High accuracy dc performance**
 - 5 ppm maximum gain nonlinearity**
 - 10 µV/°C maximum offset voltage drift**
 - 5 ppm/°C maximum gain drift**

APPLICATIONS

- High voltage current sensing**
- Battery cell voltage monitors**
- Power supply current monitors**
- Motor controls**
- Isolation**

GENERAL DESCRIPTION

The AD8479 is a difference amplifier with a very high input common-mode voltage range. The AD8479 is a precision device that allows the user to accurately measure differential signals in the presence of high common-mode voltages up to ±600 V.

The AD8479 can replace costly isolation amplifiers in applications that do not require galvanic isolation. The device operates over a ±600 V common-mode voltage range and has inputs that are protected from common-mode or differential mode transients up to ±600 V.

The AD8479 has low offset voltage, low offset voltage drift, low gain drift, low common-mode rejection drift, and excellent common-mode rejection ratio (CMRR) over a wide frequency range.

The AD8479 is available in a space-saving 8-lead SOIC package and is operational over the -40°C to +125°C temperature range.

FUNCTIONAL BLOCK DIAGRAM

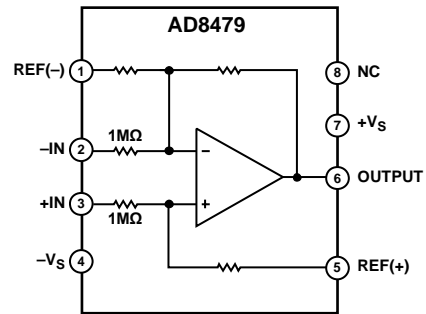

NOTES
1. NC = NO CONNECT. DO NOT CONNECT TO THIS PIN. 11118-001

Figure 1.

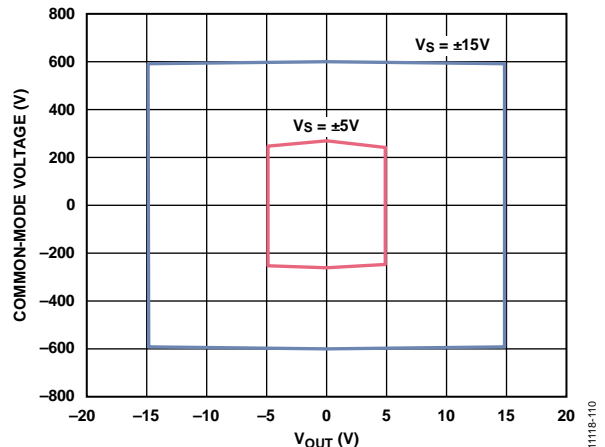

Figure 2. Input Common-Mode Voltage vs. Output Voltage

TABLE OF CONTENTS

Features	1	Applications Information	12
Applications	1	Basic Connections	12
General Description	1	Single-Supply Operation	12
Functional Block Diagram	1	System-Level Decoupling and Grounding.....	12
Revision History	2	Using a Large Shunt Resistor	13
Specifications.....	3	Output Filtering.....	14
Absolute Maximum Ratings.....	4	Gain of 60 Differential Amplifier.....	14
ESD Caution.....	4	Error Budget Analysis Example	15
Pin Configuration and Function Descriptions.....	5	Outline Dimensions	16
Typical Performance Characteristics	6	Ordering Guide	16
Theory of Operation	11		

REVISION HISTORY

4/13—Revision 0: Initial Version

SPECIFICATIONS

$V_S = \pm 15\text{ V}$, $\text{REF}(-) = \text{REF}(+) = 0\text{ V}$, $R_L = 2\text{ k}\Omega$, $T_A = 25^\circ\text{C}$, unless otherwise noted.

Table 1.

Parameter	Test Conditions/Comments	A Grade			B Grade			Unit
		Min	Typ	Max	Min	Typ	Max	
GAIN								
	$V_{\text{OUT}} = \pm 10\text{ V}$, $R_L = 2\text{ k}\Omega$							
Nominal Gain			1			1		V/V
Gain Error			0.01	0.02		0.005	0.01	%
Gain Nonlinearity			4	10		2	5	ppm
Gain Drift	$T_A = T_{\text{MIN}}$ to T_{MAX}		3	5		3	5	ppm/ $^\circ\text{C}$
OFFSET VOLTAGE								
Offset Voltage	$V_S = \pm 15\text{ V}$		0.5	3		0.5	1	mV
	$V_S = \pm 5\text{ V}$		0.5	3		0.5	1	mV
Offset Voltage Drift	$T_A = T_{\text{MIN}}$ to T_{MAX}		3	15		3	10	$\mu\text{V}/^\circ\text{C}$
Power Supply Rejection Ratio (PSRR)	$V_S = \pm 2.5\text{ V}$ to $\pm 15\text{ V}$	84	100		90	100		dB
INPUT								
Common-Mode Rejection Ratio (CMRR)	$V_{\text{CM}} = \pm 600\text{ V}$ dc							
	$T_A = 25^\circ\text{C}$	80	90		90	96		dB
	$T_A = T_{\text{MIN}}$ to T_{MAX}	80			90			dB
	$V_{\text{CM}} = 1200\text{ V}$ p-p, dc to 12 kHz	80			80			dB
Operating Voltage Range	Common-mode			± 600			± 600	V
	Differential			± 14.7			± 14.7	V
Input Operating Impedance	Common-mode		500			500		k Ω
	Differential		2			2		M Ω
OUTPUT								
Output Voltage Swing	$R_L = 2\text{ k}\Omega$	$-V_S + 0.3$		$+V_S - 0.3$	$-V_S + 0.3$		$+V_S - 0.3$	V
Output Short-Circuit Current			± 55			± 55		mA
Capacitive Load	Stable operation		500			500		pF
DYNAMIC RESPONSE								
Small Signal –3 dB Bandwidth			130			130		kHz
Slew Rate			7.5	8		7.5	8	V/ μs
Full Power Bandwidth	$V_{\text{OUT}} = 20\text{ V}$ p-p		100			100		kHz
Settling Time	0.01%, $V_{\text{OUT}} = 10\text{ V}$ step		11			11		μs
	0.001%, $V_{\text{CM}} = 10\text{ V}$ step		15.4			15.4		μs
OUTPUT VOLTAGE NOISE								
0.01 Hz to 10 Hz			30	35		30	35	μV p-p
Noise Spectral Density	$f \geq 100\text{ Hz}$		1.6			1.6		$\mu\text{V}/\sqrt{\text{Hz}}$
POWER SUPPLY								
Operating Voltage Range		± 2.5		± 18	± 2.5		± 18	V
Supply Current	$V_{\text{OUT}} = 0\text{ V}$		550	650		550	650	μA
	$T_A = T_{\text{MIN}}$ to T_{MAX}		850			850		μA
TEMPERATURE RANGE								
Specified Performance	$T_A = T_{\text{MIN}}$ to T_{MAX}	-40		$+85$	-40		$+85$	$^\circ\text{C}$
Operational		-40		$+125$	-40		$+125$	$^\circ\text{C}$

ABSOLUTE MAXIMUM RATINGS

Table 2.

Parameter	Rating
Supply Voltage, V_S	± 18 V
Input Voltage Range	
Continuous	± 600 V
Common-Mode and Differential, 10 sec	± 900 V
Output Short-Circuit Duration REF(-) and REF(+)	Indefinite $-V_S - 0.3$ V to $+V_S + 0.3$ V
Maximum Junction Temperature	150°C
Operating Temperature Range	-40°C to +125°C
Storage Temperature Range	-65°C to +150°C
Lead Temperature (Soldering, 60 sec)	300°C

Stresses above those listed under Absolute Maximum Ratings may cause permanent damage to the device. This is a stress rating only; functional operation of the device at these or any other conditions above those indicated in the operational section of this specification is not implied. Exposure to absolute maximum rating conditions for extended periods may affect device reliability.

ESD CAUTION



ESD (electrostatic discharge) sensitive device. Charged devices and circuit boards can discharge without detection. Although this product features patented or proprietary protection circuitry, damage may occur on devices subjected to high energy ESD. Therefore, proper ESD precautions should be taken to avoid performance degradation or loss of functionality.

PIN CONFIGURATION AND FUNCTION DESCRIPTIONS

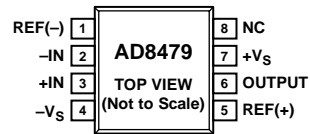

NOTES

1. NC = NO CONNECT. DO NOT CONNECT TO THIS PIN.

11118-002

Figure 3. Pin Configuration

Table 3. Pin Function Descriptions

Pin No.	Mnemonic	Description
1	REF(-)	Negative Reference Voltage Input.
2	-IN	Inverting Input.
3	+IN	Noninverting Input.
4	-Vs	Negative Supply Voltage.
5	REF(+)	Positive Reference Voltage Input.
6	OUTPUT	Output.
7	+Vs	Positive Supply Voltage.
8	NC	No Connect. Do not connect to this pin.

TYPICAL PERFORMANCE CHARACTERISTICS

$V_S = \pm 15\text{ V}$, $T_A = 25^\circ\text{C}$, unless otherwise noted.

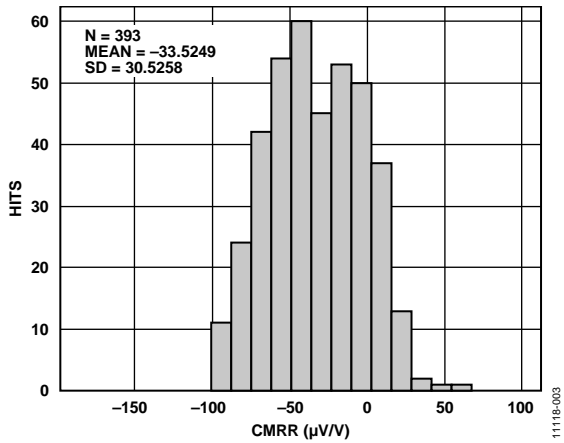

Figure 4. CMRR Distribution

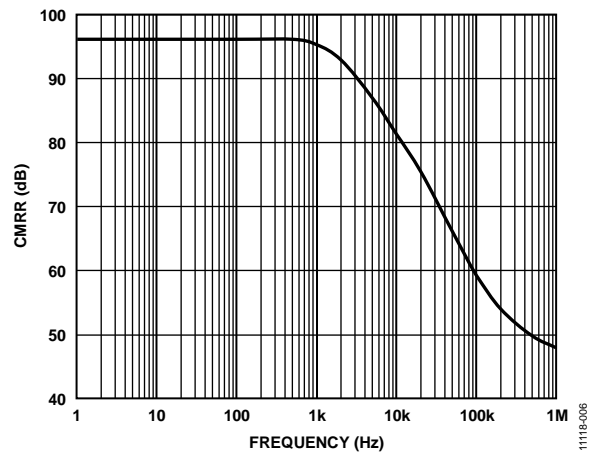

Figure 7. CMRR vs. Frequency

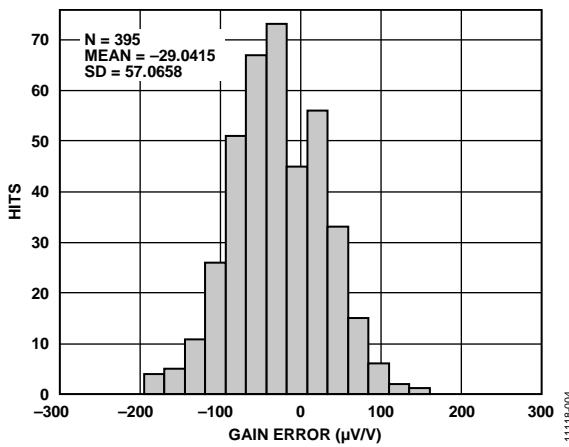

Figure 5. Gain Error Distribution

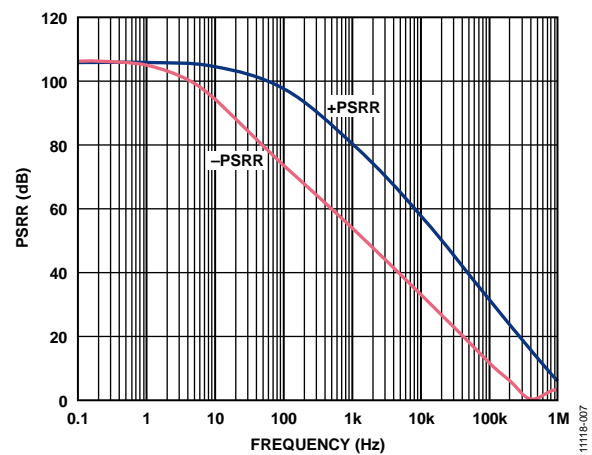

Figure 8. PSRR vs. Frequency

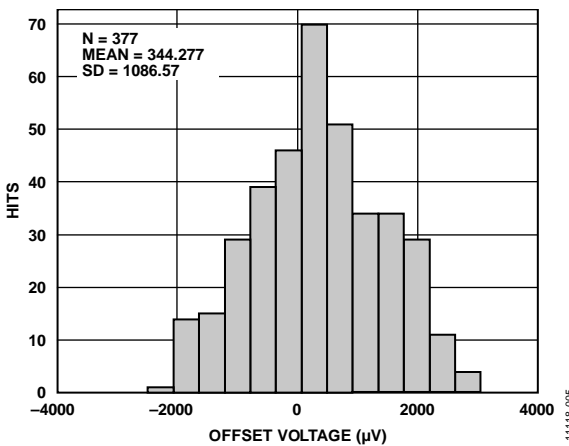

Figure 6. Offset Voltage Distribution

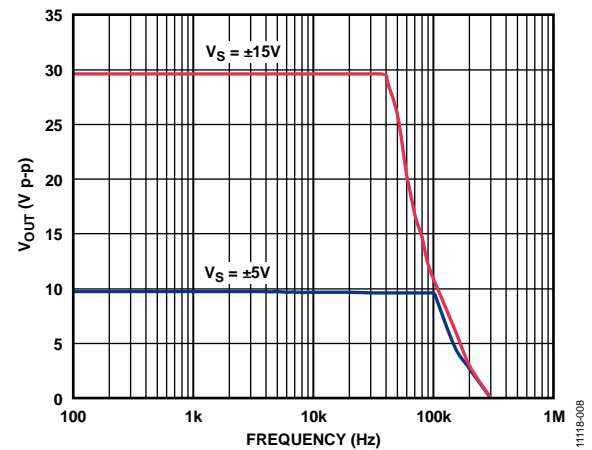

Figure 9. Large Signal Frequency Response

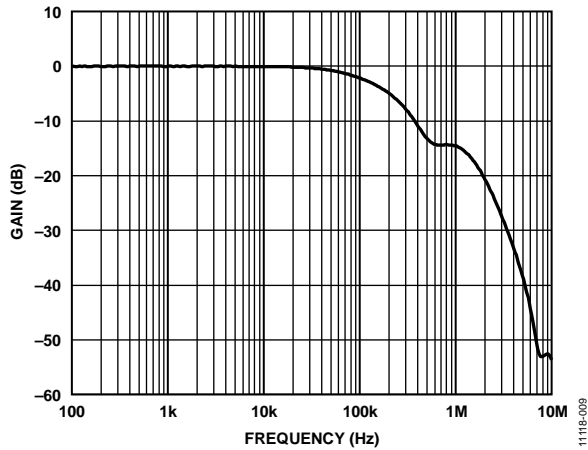

Figure 10. Small Signal Frequency Response

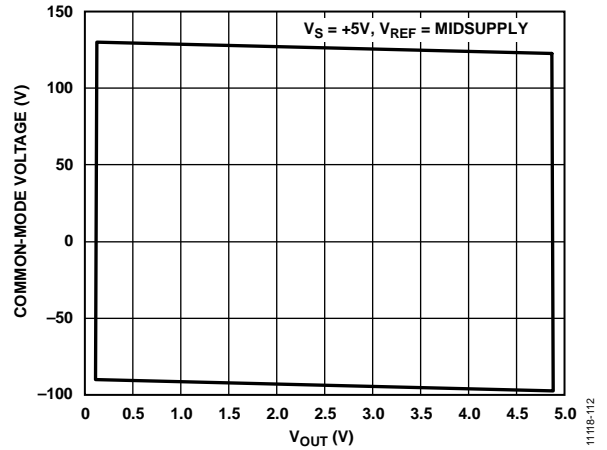

Figure 13. Input Common-Mode Voltage vs. Output Voltage, Single Supply, $V_S = +5V, V_{REF} = Midsupply$

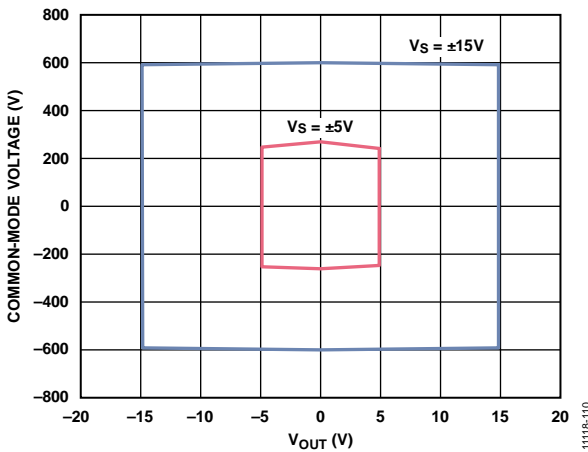

Figure 11. Input Common-Mode Voltage vs. Output Voltage, Dual Supplies, $V_S = \pm 15V, \pm 5V$

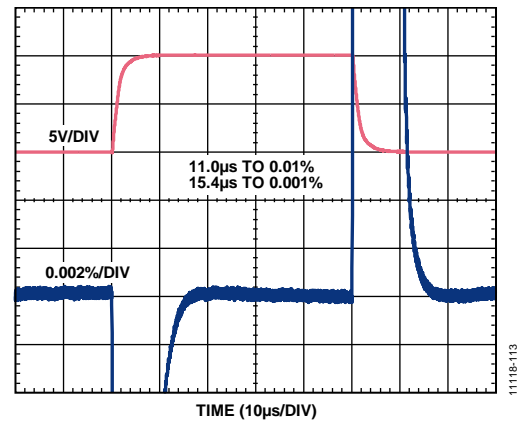

Figure 14. Settling Time

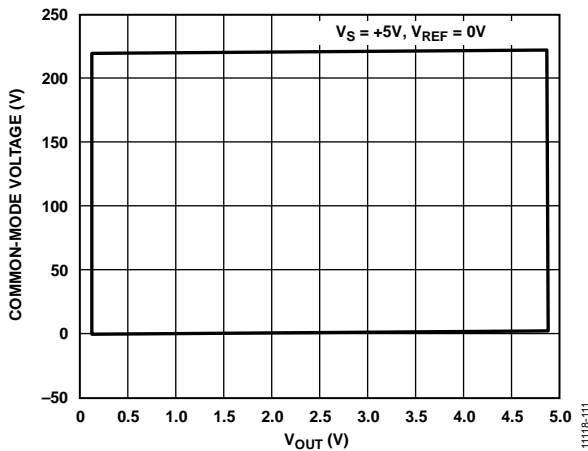

Figure 12. Input Common-Mode Voltage vs. Output Voltage, Single Supply, $V_S = +5V, V_{REF} = 0V$

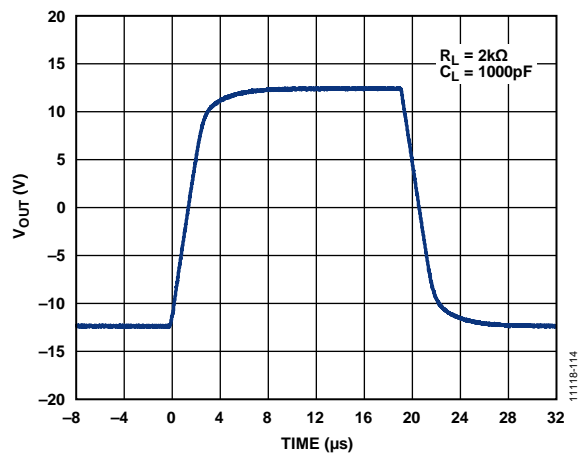

Figure 15. Large Signal Pulse Response

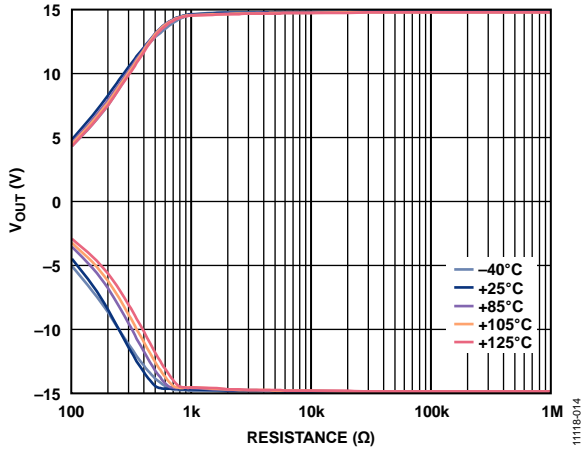

Figure 16. Output Voltage vs. Load over Temperature

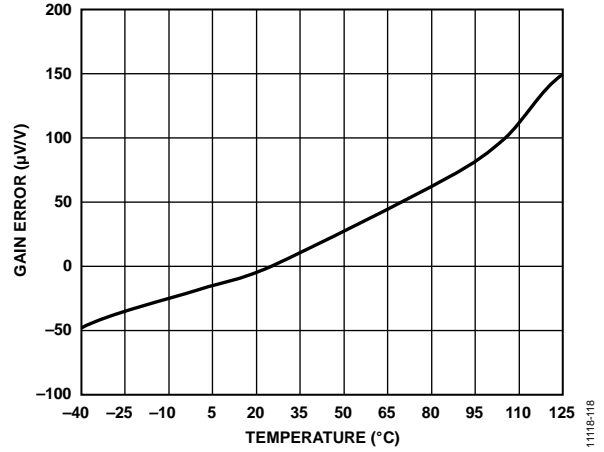

Figure 19. Gain Drift

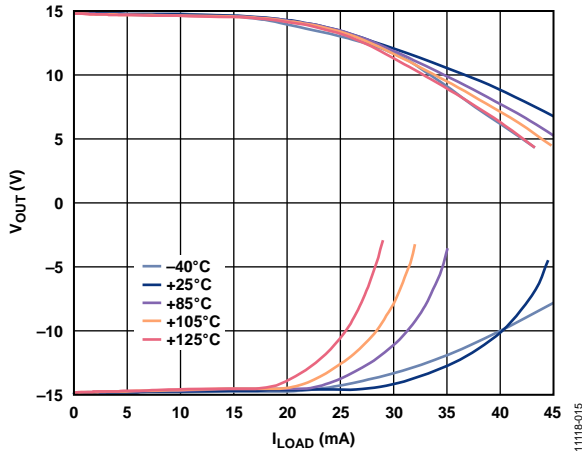

Figure 17. Output Voltage vs. Output Current over Temperature

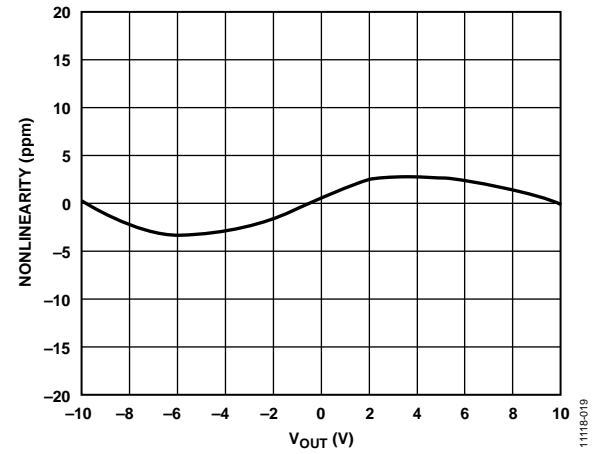

Figure 20. Gain Nonlinearity

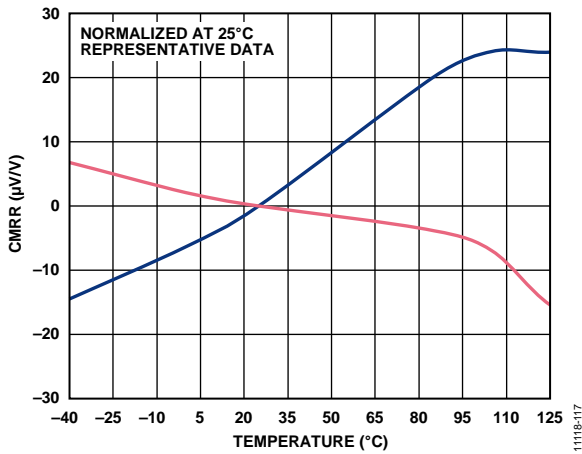

Figure 18. CMRR vs. Temperature, $V_{CM} = \pm 20 V$

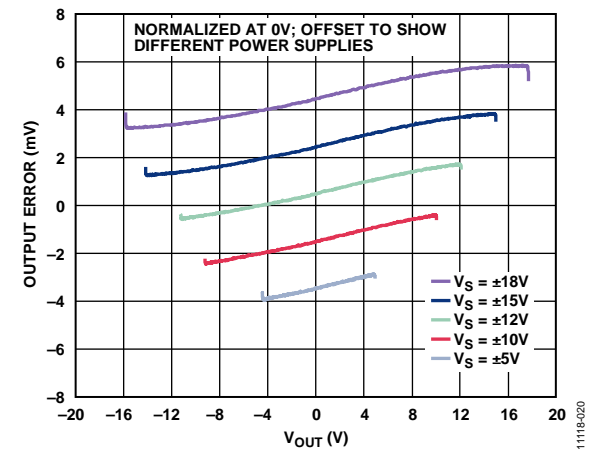

Figure 21. Output Error vs. Output Voltage, $R_L = 10 k\Omega$

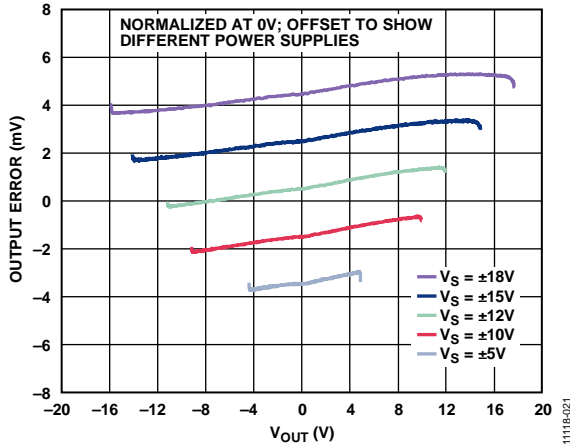

Figure 22. Output Error vs. Output Voltage, $R_L = 2\text{ k}\Omega$

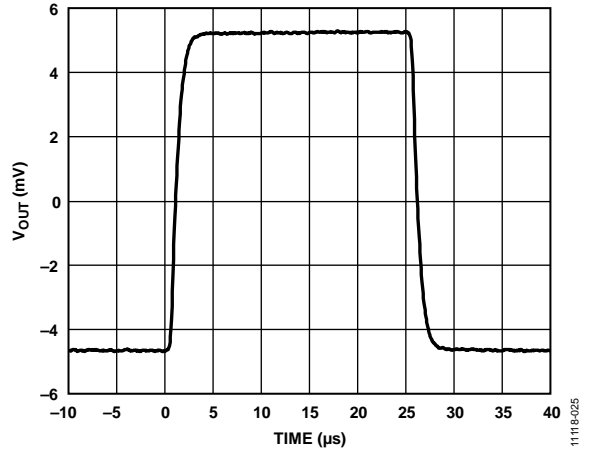

Figure 25. Small Signal Pulse Response

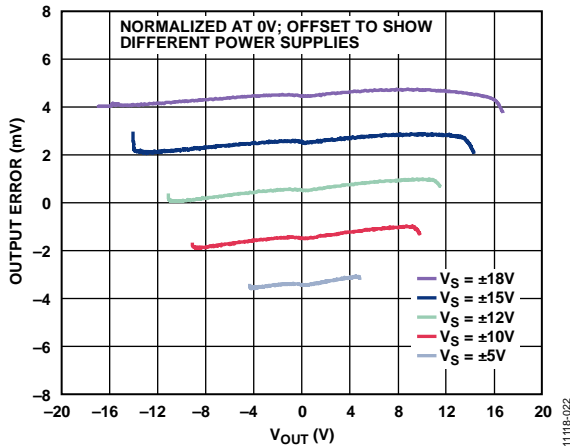

Figure 23. Output Error vs. Output Voltage, $R_L = 1\text{ k}\Omega$

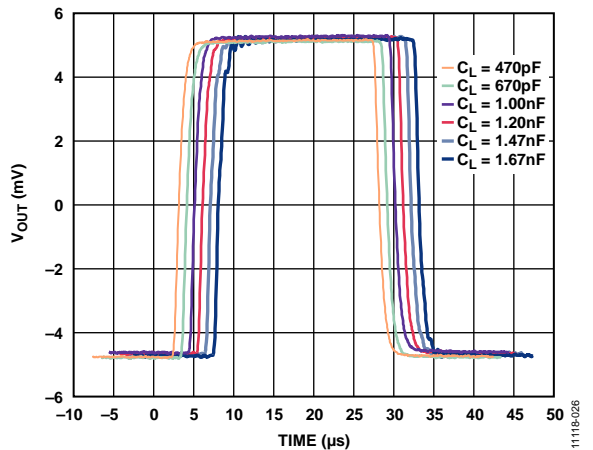

Figure 26. Small Signal Pulse Response vs. Capacitive Load

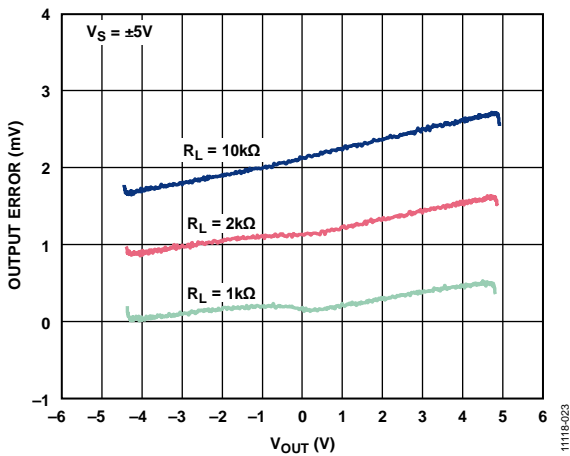

Figure 24. Output Error vs. Output Voltage, $V_S = \pm 5V$

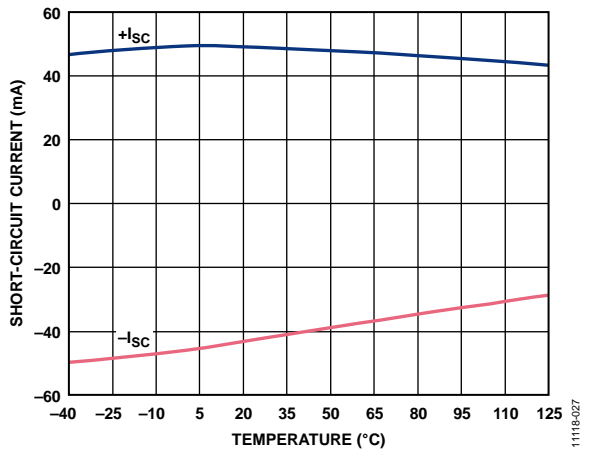

Figure 27. Short-Circuit Current vs. Temperature

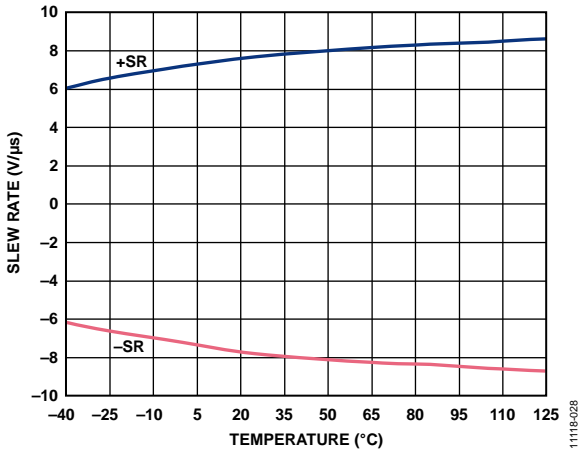

Figure 28. Slew Rate vs. Temperature

11118-028

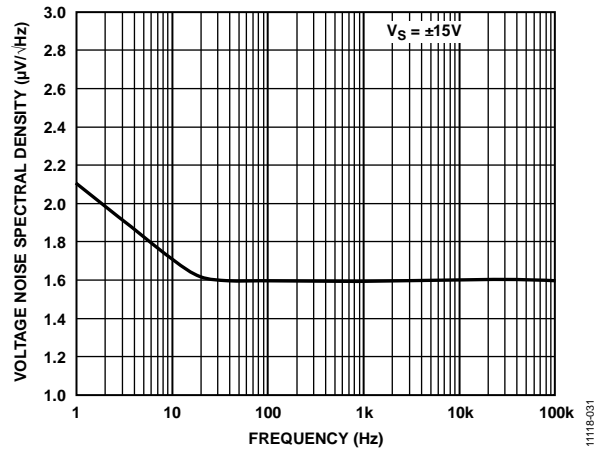

Figure 31. Voltage Noise Spectral Density vs. Frequency

11118-031

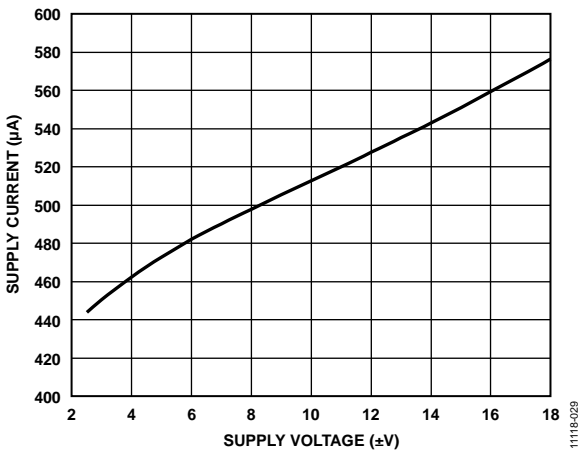

Figure 29. Supply Current vs. Supply Voltage

11118-029

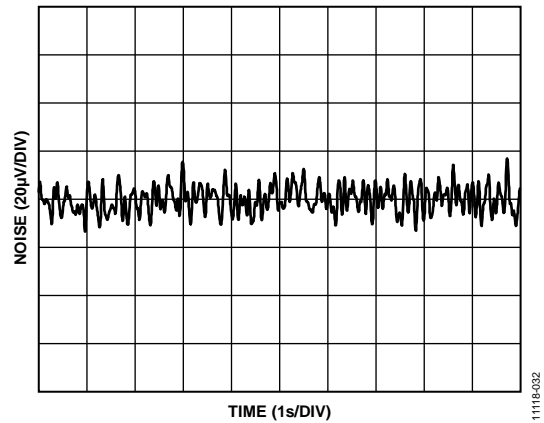

Figure 32. 0.1 Hz to 10 Hz Noise

11118-032

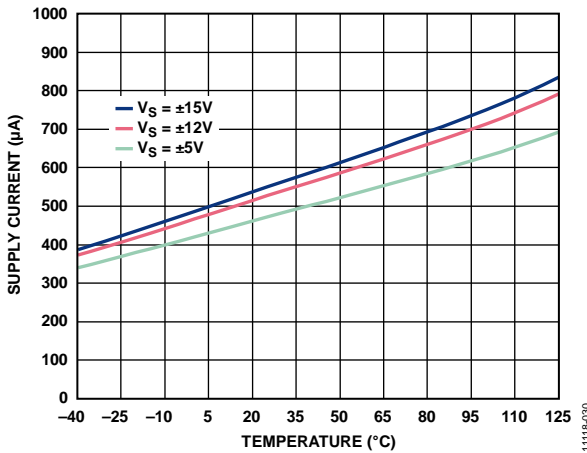
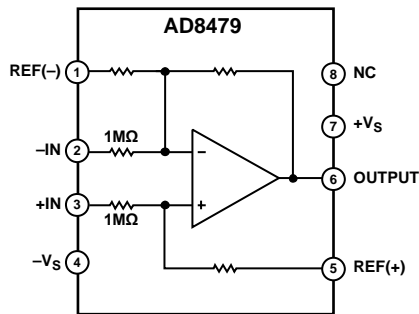

Figure 30. Supply Current vs. Temperature

11118-030

THEORY OF OPERATION

The AD8479 is a unity-gain, differential-to-single-ended amplifier that can reject extremely high common-mode signals in excess of 600 V with 15 V supplies. The AD8479 consists of an operational amplifier (op amp) and a resistor network (see Figure 33).



NOTES

1. NC = NO CONNECT. DO NOT CONNECT TO THIS PIN.

Figure 33. Functional Block Diagram

11118-033

To achieve the high common-mode voltage range, an internal resistor divider—connected to Pin 3 and Pin 5—attenuates the noninverting signal by a factor of 60. The internal resistors at Pin 1 and Pin 2, as well as the feedback resistor, restore the gain to provide a differential gain of unity.

The complete transfer function is

$$V_{OUT} = V(+IN) - V(-IN)$$

Laser wafer-trimming provides resistor matching so that common-mode signals are rejected and differential input signals are amplified.

To reduce output voltage drift, the op amp uses super beta transistors in its input stage. The input offset current and its associated temperature coefficient contribute no appreciable output voltage offset or drift, which has the added benefit of reducing voltage noise because the corner where $1/f$ noise becomes dominant is below 5 Hz. To reduce the dependence of gain accuracy on the op amp, the open-loop voltage gain of the op amp exceeds 20 million V/V, and the PSRR exceeds 90 dB.

APPLICATIONS INFORMATION

BASIC CONNECTIONS

Figure 34 shows the basic connections for operating the AD8479 with a dual supply. A supply voltage from ± 2.5 V to ± 18 V is applied across Pin 7 and Pin 4. Both supplies should be decoupled close to the pins using 0.1 μ F capacitors. Electrolytic capacitors of 10 μ F, also located close to the supply pins, may be required if low frequency noise is present on the power supply. Although multiple amplifiers can be decoupled by a single set of 10 μ F capacitors, each AD8479 should have its own set of 0.1 μ F capacitors so that the decoupling point can be located directly at the IC power pins.

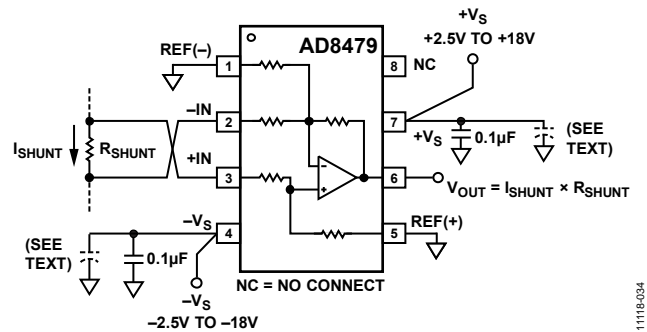

Figure 34. Basic Connections

The differential input signal, which typically results from a load current flowing through a small shunt resistor, is applied to Pin 2 and Pin 3 with the polarity shown in Figure 34 to obtain a positive gain. The common-mode voltage on the differential input signal can range from -600 V to $+600$ V, and the maximum differential voltage is ± 14.7 V. When configured as shown in Figure 34, the device operates as a simple gain-of-1, differential-to-single-ended amplifier; the output voltage is the shunt resistance times the shunt current. The output is measured with respect to Pin 1 and Pin 5.

Pin 1 and Pin 5 (REF(-) and (REF(+))) should be grounded for a gain of unity and should be connected to the same low impedance ground plane. Failure to do this results in degraded common-mode rejection. Pin 8 is a no connect pin and should be left open.

SINGLE-SUPPLY OPERATION

Figure 35 shows the connections for operating the AD8479 with a single supply. Because the output can swing to within only about 0.3 V of either rail, an offset must be applied to the output. This offset can be applied by connecting REF(+), and REF(-) to a low impedance reference voltage that is capable of sinking current (some ADCs provide this voltage as an output). Therefore, for a single supply of 10 V, V_{REF} can be set to 5 V for a bipolar input signal, allowing the output to swing ± 9.4 V around the central 5 V reference voltage. For unipolar input signals, V_{REF} can be set to approximately 1 V, allowing the output to swing from 1 V (for a 0 V input) to within 0.3 V of the positive rail.

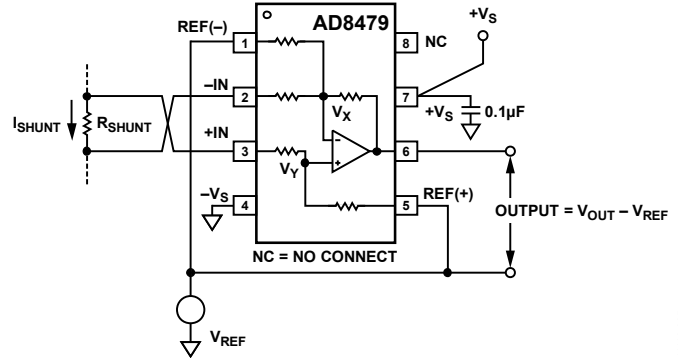

Figure 35. Operation with a Single Supply

When the AD8479 is operated with a single supply and a reference voltage is applied to REF(+), and REF(-), the input common-mode voltage range of the AD8479 is reduced. The reduced input common-mode range depends on the voltage at the inverting and noninverting inputs of the internal op amp, labeled V_X and V_Y in Figure 35. These nodes can swing to within 1 V of either rail. Therefore, for a single supply voltage of 10 V, V_X and V_Y can have a value from 1 V to 9 V. If V_{REF} is set to 5 V, the allowable common-mode voltage range is $+245$ V to -235 V. The common-mode voltage range can be calculated as follows:

$$V_{CM}(\pm) = 60 \times (V_X \text{ or } V_Y(\pm)) - (59 \times V_{REF})$$

SYSTEM-LEVEL DECOUPLING AND GROUNDING

The use of ground planes is recommended to minimize the impedance of ground returns and, therefore, the size of dc errors. Figure 36 shows how to use grounding in a mixed-signal environment, that is, with digital and analog signals present. To isolate low level analog signals from a noisy digital environment, many data acquisition components have separate analog and digital ground returns. All ground pins from mixed-signal components, such as ADCs, should return through a low impedance analog ground plane. Digital ground lines of mixed-signal converters should also be connected to the analog ground plane.

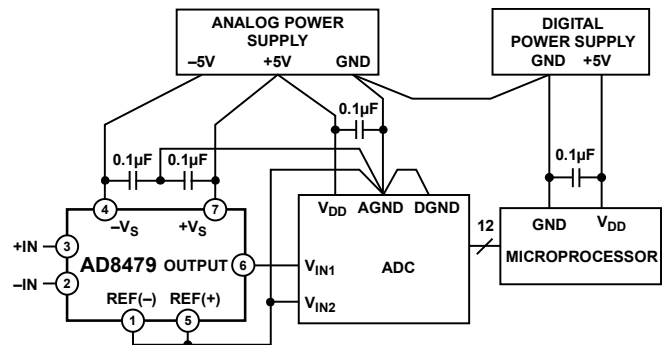

Figure 36. Optimal Grounding Practice for a Dual Supply Environment with Separate Analog and Digital Supplies

Typically, analog and digital grounds should be separated. At the same time, however, the voltage difference between digital and analog grounds on a converter must also be minimized to keep this difference as small as possible (typically <math><0.3\text{ V}</math>). The increased noise—caused by the digital return currents of the converter flowing through the analog ground plane—is typically negligible.

Maximum isolation between analog and digital signals is achieved by connecting the ground planes back to the supplies. Note that Figure 36 suggests a star ground system for the analog circuitry, with all ground lines connected, in this case, to the analog ground of the ADC. However, when ground planes are used, it is sufficient to connect ground pins to the nearest point on the low impedance ground plane.

If only one power supply is available, it must be shared by both digital and analog circuitry. Figure 37 shows how to minimize interference between the digital and analog circuitry. In Figure 37, the reference of the ADC is used to drive the REF(+) and REF(-) pins of the AD8479. This means that the reference must be capable of sourcing and sinking a current equal to $V_{CM}/500\text{ k}\Omega$.

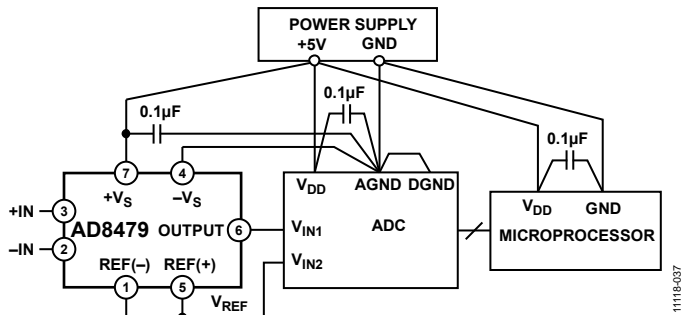

Figure 37. Optimal Grounding Practice for a Single-Supply Environment

As in the dual-supply environment, separate analog and digital ground planes should be used (although reasonably thick traces can be used as an alternative to a digital ground plane). These ground planes should connect at the ground pin of the power supply. Separate traces (or power planes) should run from the power supply to the supply pins of the digital and analog circuits. Ideally, each device should have its own power supply trace, but these traces can be shared by a number of devices, as long as a single trace is not used to route current to both digital and analog circuitry.

USING A LARGE SHUNT RESISTOR

The insertion of a large value shunt resistor across the input pins, Pin 2 and Pin 3, unbalances the input resistor network, thereby introducing common-mode error. The magnitude of the error depends on the common-mode voltage and the magnitude of the shunt resistor (R_{SHUNT}).

Table 4 shows some sample error voltages generated by a common-mode voltage of 600 V dc with shunt resistors from 20 Ω to 2000 Ω . Assuming that the shunt resistor is selected to use the full $\pm 10\text{ V}$ output swing of the AD8479, the error voltage becomes quite significant as the value of R_{SHUNT} increases.

Table 4. Error Resulting from Large Values of R_{SHUNT} (Uncompensated Circuit)

$R_{SHUNT} (\Omega)$	Error $V_{OUT} (V)$	Error Indicated (mA)
20	0.012	0.6
1000	0.583	0.6
2000	1.164	0.6

To measure low current or current near zero in a high common-mode voltage environment, an external resistor equal to the shunt resistor value can be added to the low impedance side of the shunt resistor, as shown in Figure 38.

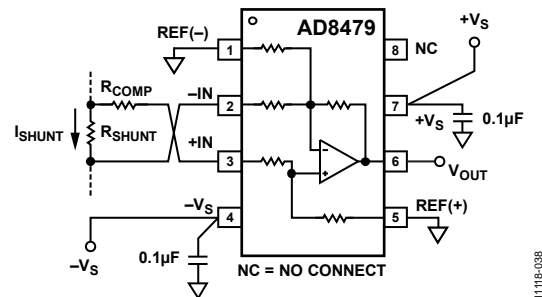

Figure 38. Compensating for Large Shunt Resistors

OUTPUT FILTERING

To limit noise at the output, a simple two-pole, low-pass Butterworth filter can be implemented using the ADA4077-2 after the AD8479, as shown in Figure 39.

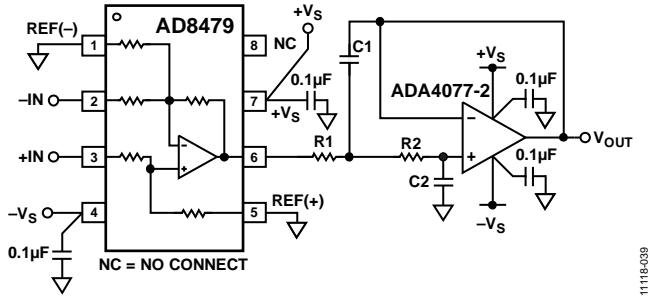

Figure 39. Filtering Output Noise Using a Two-Pole Butterworth Filter

Table 5 provides recommended component values for various corner frequencies, along with the peak-to-peak output noise for each case.

Table 5. Recommended Values for Two-Pole Butterworth Filter

Corner Frequency	R1	R2	C1	C2	Output Noise (p-p)
50 kHz	2.94 kΩ ± 1%	1.58 kΩ ± 1%	2.2 nF ± 10%	1 nF ± 10%	2.9 mV
5 kHz	2.94 kΩ ± 1%	1.58 kΩ ± 1%	22 nF ± 10%	10 nF ± 10%	0.9 mV
500 Hz	2.94 kΩ ± 1%	1.58 kΩ ± 1%	220 nF ± 10%	0.1 µF ± 10%	0.296 mV
50 Hz	2.7 kΩ ± 10%	1.58 kΩ ± 10%	2.2 µF ± 20%	0.1 µF ± 20%	0.095 mV
No Filter					4.7 mV

GAIN OF 60 DIFFERENTIAL AMPLIFIER

Low level signals can be connected directly to the -IN and +IN inputs of the AD8479. Differential input signals can also be connected to give a precise gain of 60 (see Figure 40); however, large common-mode voltages are no longer permissible. Cold junction compensation can be implemented using a temperature sensor, such as the AD590.

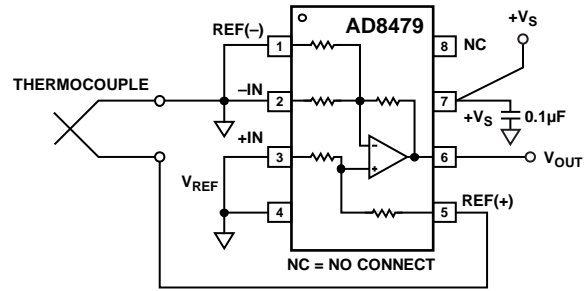

Figure 40. Gain of 60 Thermocouple Amplifier

ERROR BUDGET ANALYSIS EXAMPLE

In the dc application described in this section, the 10 A output current from a device with a high common-mode voltage (such as a power supply or current-mode amplifier) is sensed across a 1 Ω shunt resistor (see Figure 41). The common-mode voltage is 600 V, and the resistor terminals are connected through a long pair of lead wires located in a high noise environment, for example, 50 Hz/60 Hz, 440 V ac power lines.

The calculations in Table 6 assume an induced noise level of 1 V p-p at 60 Hz on the lead wires, in addition to a full-scale dc differential voltage of 10 V. The error budget table quantifies the contribution of each error source. Note that the dominant error source in this example is due to the dc common-mode voltage.

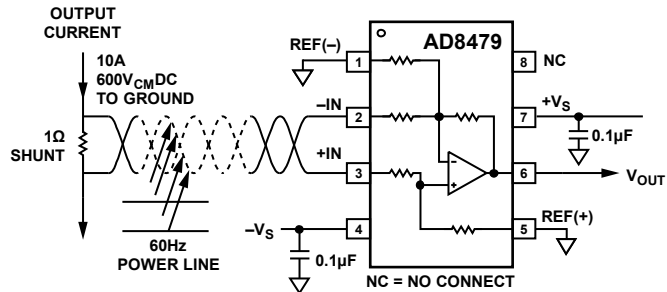
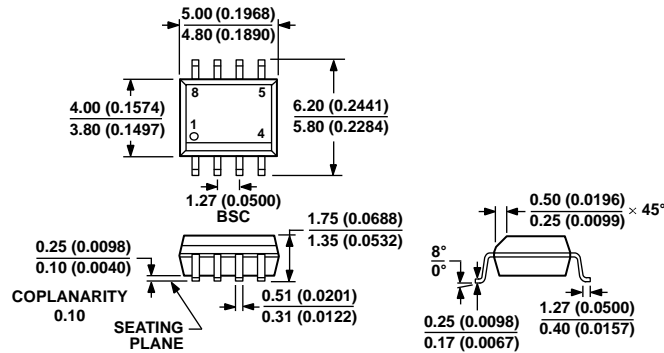

Figure 41. Error Budget Analysis Example: $V_{IN} = 10\text{ V Full Scale}$, $V_{CM} = 600\text{ V DC}$, $R_{SHUNT} = 1\ \Omega$, 1 V p-p , $60\text{ Hz Power Line Interference}$

Table 6. Error Budget Analysis Example ($V_{CM} = 600\text{ V DC}$)

Error Source	Calculation of Error	Error (ppm of FS)
ACCURACY, $T_A = 25^\circ\text{C}$		
Initial Gain Error	$(0.0001 \times 10)/10\text{ V} \times 10^6$	100
Offset Voltage	$(0.001\text{ V}/10\text{ V}) \times 10^6$	100
DC CMR (Over Temperature)	$(32 \times 10^{-6} \times 600\text{ V})/10\text{ V} \times 10^6$	1920
	Total Accuracy Error	2120
TEMPERATURE DRIFT (85°C)		
Gain Drift	$5\text{ ppm}/^\circ\text{C} \times 60^\circ\text{C}$	300
Offset Voltage Drift	$(10\ \mu\text{V}/^\circ\text{C} \times 60^\circ\text{C}) \times 10^6/10\text{ V}$	60
	Total Temperature Drift Error	360
RESOLUTION		
Noise, Typical, 0.01 Hz to 10 Hz, $\mu\text{V p-p}$	$35\ \mu\text{V}/10\text{ V} \times 10^6$	4
CMR, 60 Hz	$(32 \times 10^{-6} \times 1\text{ V})/10\text{ V} \times 10^6$	3
Nonlinearity	$(5 \times 10^{-6} \times 10\text{ V})/10\text{ V} \times 10^6$	5
	Total Resolution Error	12
	Total Error	2492

OUTLINE DIMENSIONS



COMPLIANT TO JEDEC STANDARDS MS-012-AA
 CONTROLLING DIMENSIONS ARE IN MILLIMETERS; INCH DIMENSIONS
 (IN PARENTHESES) ARE ROUNDED-OFF MILLIMETER EQUIVALENTS FOR
 REFERENCE ONLY AND ARE NOT APPROPRIATE FOR USE IN DESIGN.

Figure 42. 8-Lead Standard Small Outline Package [SOIC_N]
 Narrow Body
 (R-8)

Dimensions shown in millimeters and (inches)

012407-A

ORDERING GUIDE

Model ¹	Temperature Range	Package Description	Package Option
AD8479ARZ	-40°C to +125°C	8-Lead SOIC_N	R-8
AD8479ARZ-RL	-40°C to +125°C	8-Lead SOIC_N, 13-Inch Tape and Reel, 2,500 pieces	R-8
AD8479BRZ	-40°C to +125°C	8-Lead SOIC_N	R-8
AD8479BRZ-RL	-40°C to +125°C	8-Lead SOIC_N, 13-Inch Tape and Reel, 2,500 pieces	R-8

¹ Z = RoHS Compliant Part.